

Panel List

Note: Separate and stack panels by like types before beginning assembly process.

Fixed Projector & Document Camera Cabinet

- 1 Top Panel • 1 Back Panel • 1 Left End Panel • 1 Right End Panel
- 1 Bottom Panel • 1 Adjustable Shelf • 1 Storage Door • 1 Toe Kick Panel

- = Cam Fitting
- = Cam Hole
- = Screw Hole/Spoon Pin
- = RV Fitting
- ⊗ = Grommet/wire access

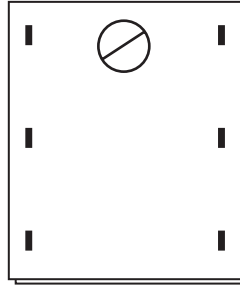

Top Panel (1 ea.)

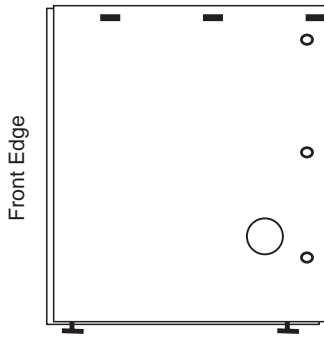

Left End Panel (1 ea.)

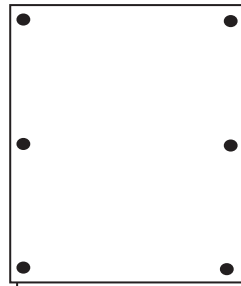

Back Panel (1 ea.)

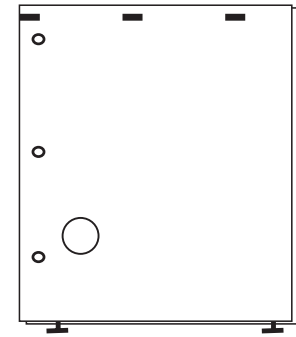

Right End Panel (1 ea.)



Toe Kick Panel (1 ea.)

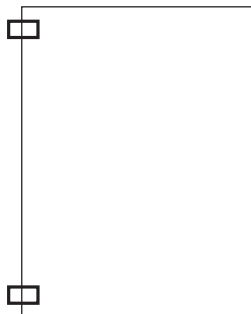

Storage Door (1 ea.)

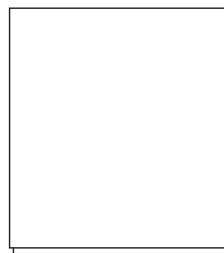

Adjustable Shelf (1 ea.)

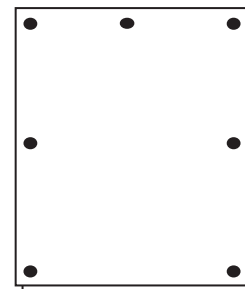

Bottom Panel (1 ea.)

The Smartdesk is packaged ready to be assembled. Included is a Master Parts and Panel List showing diagrams of all parts and hardware required for assembly. Please note, improper installation may void Smartdesk warranty. To install correctly follow the enclosed instructions. If you need additional assistance or information please contact Technical Service at 410-922-6005. © Copyright Smartdesks Ltd. 1999. All rights reserved.

Hardware Inventory Sheet

1 person is needed to assemble

Smartdesks Storage and Support Components: Fixed Projector & Document Camera Cabinet Model SPX-243030-MDL

Unpack Parts and Hardware:

Parts and panels will vary according to Smartdesks model. See Parts & Panels List and Hardware Inventory Sheet. Please verify all parts and quantities prior to assembly. Contact the factory if your quantities are incomplete. *Note: All panels are predrilled ready for assembly.*

Tools needed for assembly:

Power drill with #2 Phillips screwdriver bit and regular #2 Phillips screwdriver.

The following diagram shows the contents of the hardware bag.

Contents of Hardware Bag : (quantities for each unit - multiply by number of components)

extra hardware parts packaged to account for possible loss during shipping.

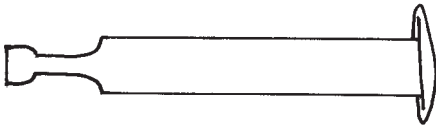

10 ea. - Cam Pins
push through holes in panels.
(Side, Back, and
Bottom Panels)

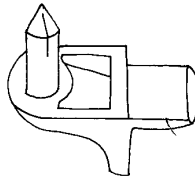

2 ea.- Earthquake Pins
for Printer/Storage Shelf
(front holes)

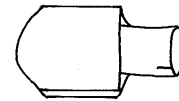

2 ea.- Shelf Spoon Pins
for Adjustable Shelf (rear holes)



**2 ea. - Hinge Plate
Screw Cover Caps**
to cover Hinge Plate
Screws

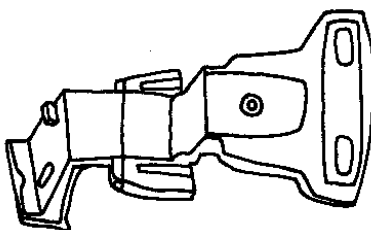

2 ea. - Hinge Plates

Smartdesks have been designed and tested as an ergonomically correct and space saving unit. For more information on this and other Smartdesks products, call 1-800-770-7042 or visit our website at <http://www.smartdesks.com>

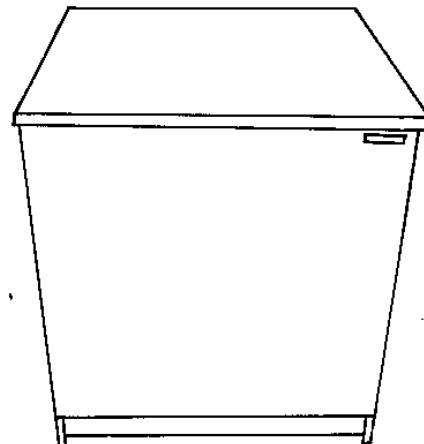

**Smartdesks Storage and Support Components:
Fixed Projector & Document Camera Cabinet
Model SPX-243030-MDL**

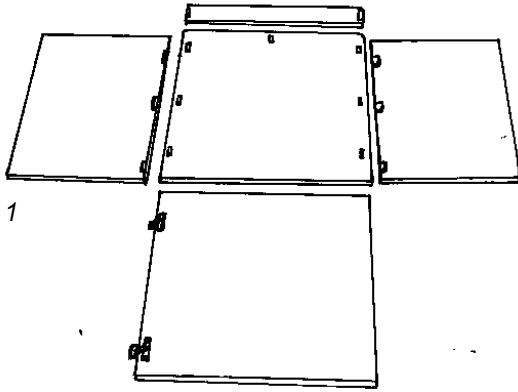
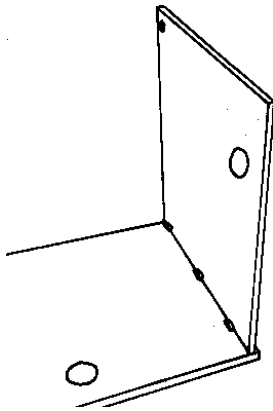

Figure 1

STEP 1 - Top & Side Panel Assembly

In a clean work area lay Top Panel with top facing down on the floor on cardboard or carpet/packing quilt. (Fig. 1)

Figure 2



Lift and place Left Side Panel into 90° vertical position with fittings facing in. While holding right panel in vertical position, match RV Fittings to one another and snap panel into place. Use power drill to tighten the screw contained in the RV Fitting. (Fig.2) Each RV Fitting contains a screw to lock the hardware once the panels have been snapped into place. Warranty is void if all locking screws have not been tightened. RV Fittings come preinstalled in panels and are equally spaced along Top edge. Tighten all remaining RV Fittings along panel edge. (Fig.3)

Repeat STEP 1 for the installation of the Left Side Panel.

Figure 3

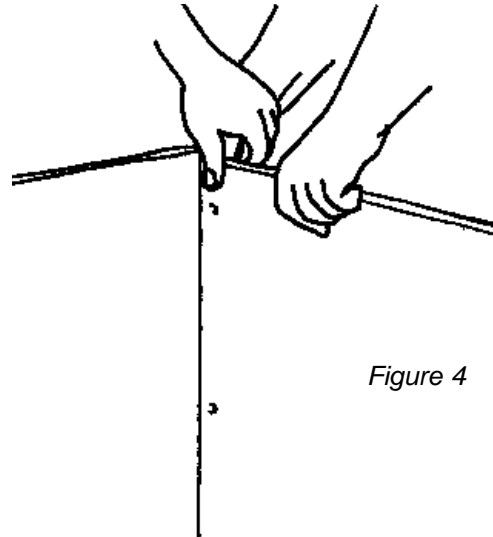
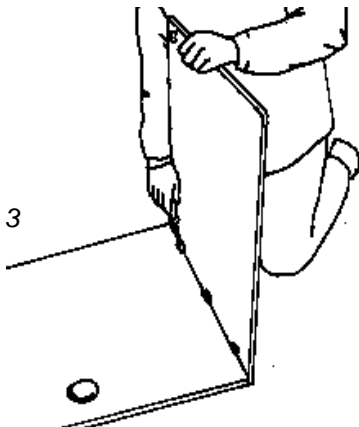

Figure 4

STEP 2 - Back Panel To Sides Assembly

NOTE: 2 person assembly required for proper fit.

Slide Back Panel into position between two Side Panels matching the cam fittings to the holes at top. It is necessary for 2 people to accomplish this assembly. Vertical panels cannot be left standing unsupported (Fig.4) Insert top 2 Cam Pins through Left and Right Side Panels into cam fittings. (Fig. 5) Start at the top cam of each end panel when inserting Cam Pins and move down each end panel alternating as Cam Pins are inserted. Make sure arrows on Cam Pins are facing out (3 pm clock position).

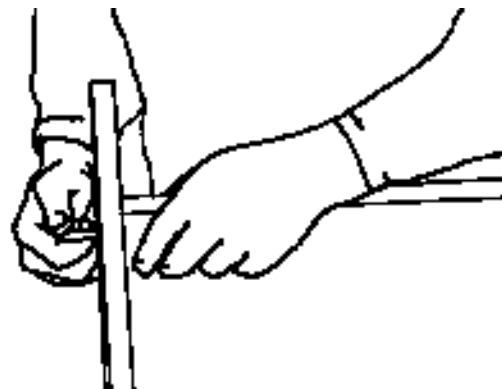
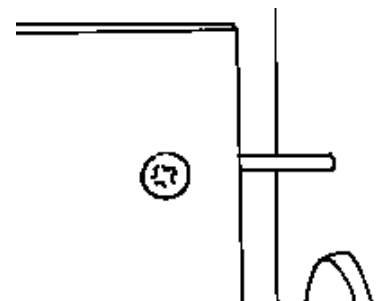

Figure 5



STEP 2 - Back Panel To Sides Assembly (cont.)

NOTE: 1 person assembly required for proper fit.

Tighten about 1/4 turn with screwdriver until it locks into place. (Fig. 6) Repeat this step for remaining Cam Pins. The Cam Pin is a steel to steel assembly which ensures heavy duty strength when assembled. (Once Back Panel is secured to Left and Right Side Panels, the "shell" of the unit is assembled. (Fig. 7))

Figure 6

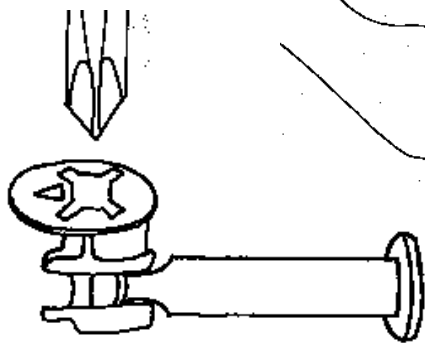
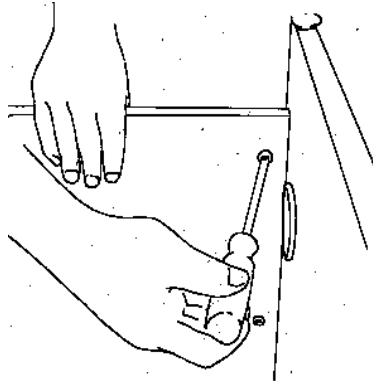

Check to verify that arrow is pointing perpendicular to pin when Cam is locked.

Cam pin is inserted through panel into preinstalled fitting.

Figure 7

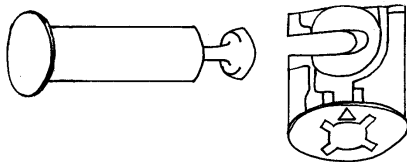

Figure 8

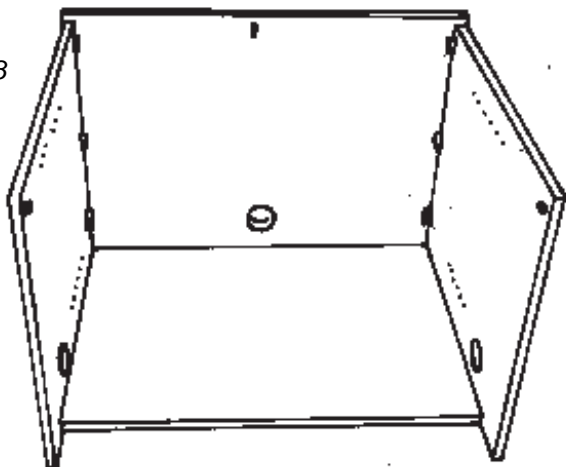

Figure 8 Smartdesks Storage & Support Component SPX -302430-FDx/Fxx Unit Back & Side Panels Assembled

STEP 3 - Bottom Panel Assembly

NOTE: 1 person assembly is required for proper fit.

The Bottom Panel is not adjustable. Make sure arrows on cams are facing out. With cabinet laying on its back, push 2 Cam Pins through one side. Align predrilled hole on Bottom Panel with Cam Pins that have been pushed through. Then slide the Bottom Panel into position. Align holes and Cam Pins. Slide Bottom Panel in place. (Fig. 9) For opposite side, Bottom Panel is already set in place. Insert Cam Pins through holes into Bottom Panel. Tighten only the left side of Cam Fittings BEFORE mounting the Toe Kick Panel. (Fig. 10)

Figure 9

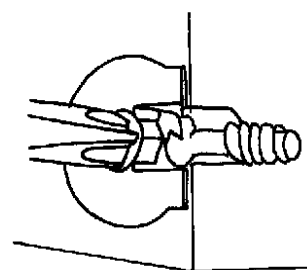
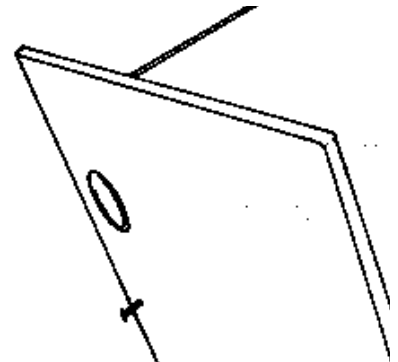

Figure 10

STEP 4 - Toe Kick Assembly

NOTE: 1 person assembly is required for proper fit.

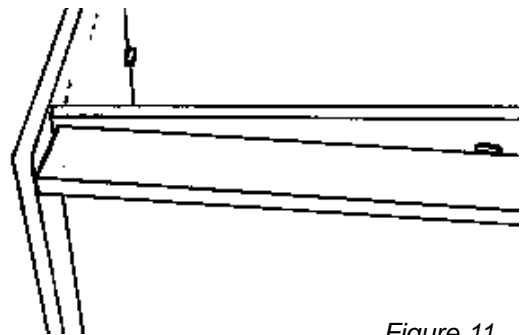

Figure 11

While holding Toe Kick Panel with the front facing up, match RV Fittings to one another and snap the left side of the Toe Kick Panel into place. Left side of the Toe Kick Panel is now temporarily mounted. (Fig. 11)

STEP 4 - Toe Kick Assembly (cont.)

NOTE: 1 person assembly is required for proper fit.

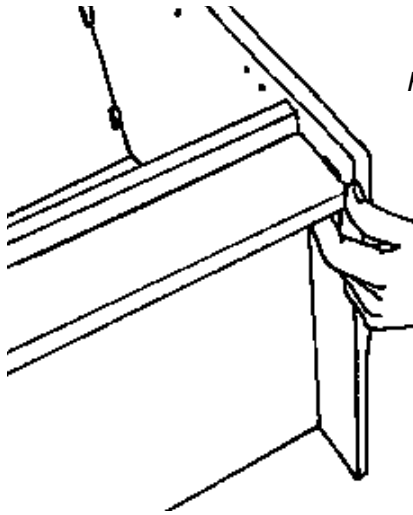

Figure 12

Gently spread the Bottom and Right Side Panels apart so that the RV Fittings of the right side of the Toe Kick Panel can be matched and snapped into place. (Fig. 12) It is necessary to tighten the last 2 Cam Fittings on the bottom and tighten the RV Fittings on the Toe Kick Panel.

STEP 5 - Flip SPX Unit 180° to Upright Position

NOTE: 2 persons required for this step.

Roll SPX unit on its back then to its upright position. (Fig. 13)

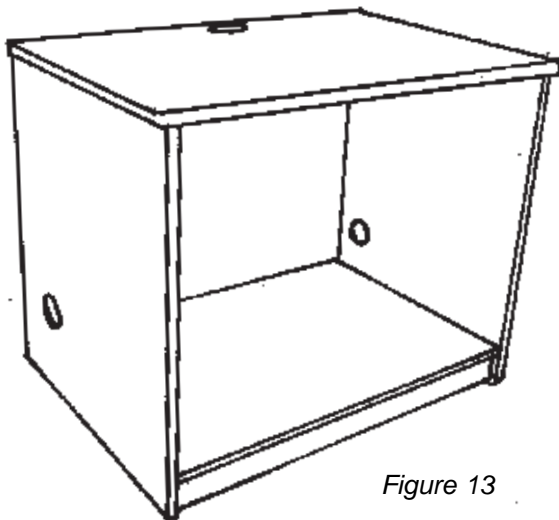

Figure 13

STEP 6 - Installation of Storage Door

Lift and place Storage Door to match hinge fittings of Right Side Panel. Snap hinge fittings together. (Fig.14) Close Storage Door.

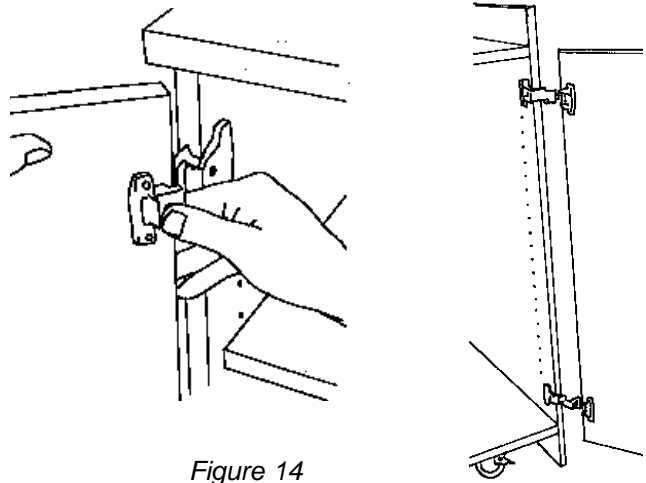

Figure 14

STEP 6 - Adjustable Shelf

NOTE: 1 person assembly is required for proper fit.

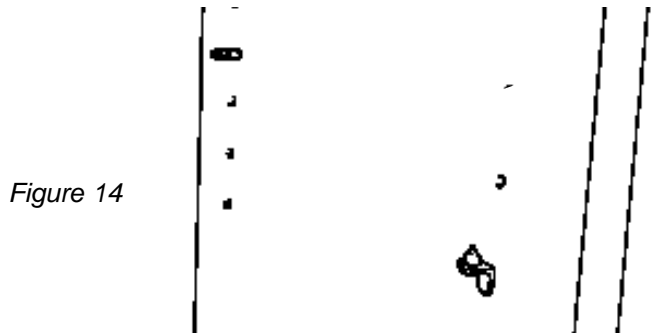

Figure 14

2 sets of predrilled holes in side panels are used for the Adjustable Shelf. Insert Earthquake Pins. Push 1 Earthquake Pin in front hole of Left and Right Side Panel. Insert Shelf Spoon Pins. Push 1 Shelf Spoon Pin in matching level rear holes of Left and Right Side Panel. (Fig. 14)

Slide Adjustable Shelf into place and rest on top of pins. (Fig. 15) Adjustable Shelf should be parallel to Top Panel.

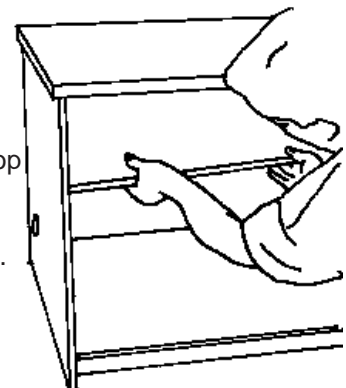

Figure 15