

SMARTdesks®

FFIT™

Computer Floor

for interactive space

Move power and data
as easily as moving
the furniture.

Installation

INTRODUCTION

These instructions and procedures have been prepared as part of a comprehensive program for the training and subsequent certification of parties installing FFIT Floor Cable Management Systems. FFIT Floor strives to provide its customers with the most advanced cable management systems on the market. Systems that will meet the client's initial requirements, as well as their future ones. One of the most important aspects of meeting this goal is providing a consistent and professional installation.

FFIT Floor will honor its product warranty, only if the system has been installed by a FFIT Floor Certified Installation company. Certification is obtained by having at least one, field supervisory staff member, complete the factory sponsored training. It is the responsibility of every Certified FFIT Floor Installation company, to maintain at least one certified supervisory staff member, and that this staff member is present on every installation, to assure that the system has been handled and installed properly.

A FFIT Floor Cable Management System provides products and services across several different areas of expertise. Installation of the systems requires learning and working with carpet tiles, pre-manufactured electrical systems, Data/Comm outlets and cabling, as well as some basic carpentry skills for the installation of the floor structure, ramps, and rails.

Training and subsequent certification will be complete in every way possible. Training will include a review of all procedures and instructions for the handling and installation of all FFIT Floor products. Training will also cover possible future work, such as reconfigurations, additions, changes, and relocations of an existing project.

Certified Installation companies will be responsible for providing certain tools and supplies to complete FFIT Floor installations. Please review the Tools & Supplies section of this manual.

Every effort has been made to cause our training to be complete. However, every installation has the potential of being different. FFIT Floor remains committed to providing a complete system, which includes a professional installation. If you have any questions, contact our offices for instructions or assistance.

FFIT Floor, reserves the right to make product revisions and improvements at any time, that may affect the installation procedures as stated herein. FFIT Floor will make every effort possible to keep its certified installers apprised of any changes to this manual or its installation procedures.

TABLE OF CONTENTS

Section 1	Getting Started
Section 2	Recommended Tool & Supply List
Section 3	Product Receiving & Staging Procedures
Section 4	Sub-Floor Inspection & Preparation
Section 5	Installing Foam Underlay
Section 6	Panel Layout & Installation
Section 7	Installing Perimeter
Section 8	Installing Ramps & Railings
Section 9	Installing Electrical System
Section 10	Installing Data / Comm Systems
Section 11	Completing the Project
Section 12	Recessed Floors
Section 13	Replacing Carpet Tiles
Section 14	Outlet Service & Relocation

Getting Started

The cornerstone of any FFIT Floor installation is the Project Shop Drawing. A sample of a FFIT Floor drawing is included herein for your review, and is referenced many times throughout this manual, as a sample. **Before starting any project, you must obtain a copy of the Project Shop drawing.** They are available in both printed and electronic formats for your use. In the header block of the drawing, you will see a Project number. You will need to refer to this number in any communications with the factory.

The project drawing will illustrate quantity and configuration of ramp / rail access points, building connection points for electrical and Data / Comm, as well as a complete product layout. A review of the project drawing will assist you in determining the tools and supplies you will be required to provide.

During the specification and procurement phases of the project, the customer was informed of the site preparation elements that need to be addressed for an installation to commence. Following are some of those basic or general points;

Levelness of Sub-Floor – The FFIT Floor chase way floor is not a corrective floor and cannot be leveled to correct any un-levelness of the sub-floor. FFIT Floor will telegraph the levelness of the sub-floor as it exists. It is recommended that the sub-floor be level within 1/8" +/- (3.18 mm) per 10'-0" of horizontal distance. This is not a requirement, and the client has been informed that FFIT Floor can be installed on any sub-floor deemed acceptable to them, for a normal carpet installation. If you determine that the sub-floor is considerably out of level, check with the client for acceptability of the sub-floor prior to starting your installation.

Electrical – The Single Ended power input cable assemblies are to be installed by a **licensed electrical contractor**. It is recommended that these cables be located and provided to the appropriate party as soon as possible. In some instances, these cable assemblies have been provided in advance of your installation, and may have been previously installed, awaiting your connection to the balance of the system.

Existing Cove Base – Vinyl Cove base must be removed prior to the start of an installation. This typically, is not an issue for new construction, but can be for those installations that are renovations or additions to existing spaces. If upon arrival, you determine that these elements have not been removed, you need to advise the client of this requirement. Baseboard moldings are also typically removed, however if client determines that they remain, they must provide a smooth even vertical surface, 3" in height minimally, to provide an acceptable edge for the FFIT Floor system.

Existing Carpeting – FFIT Floor recommends that any existing carpeting be removed prior to the installation, to assure a firm and stable surface for the floor panels to sit. However, in some cases it is not desirable for the client to remove existing carpeting. If the client wishes to install the FFIT Floor system on top of existing carpeting it is permissible, but the client must understand and accept that additional softness or sponginess may occur as a result of the thickness of the carpet pile. If the client decides and accepts the installation of the system on top of existing carpet, the Volara foam underlay is not used.

RECOMMENDED TOOL & SUPPLY LIST

TOOL REQUIREMENTS

The following is a list of tools that will be required to perform a complete and professional installation.

One of the most important processes of the installation is the “cutting to fit” of the perimeter components. This is accomplished using either a Bench type Band Saw or a Miter type Chop Saw. The chop saw is faster and provides a straighter cut, however it is much noisier. The band saw allows for easier cutting of curves, odd angles and is much quieter. Either saw must be capable of cutting a material size of 3” high x 10” wide in a single pass in order to be effective for the installation.

1. Band Saw with 12” throat / 1 HP recommended (see Picture 2-1)
2. Extra blades - 6 TPI - Teeth per Inch Recommended
3. Chop Saw with or without draw feature (see Picture 2-2)
4. Appropriate Saw Blade for the Chop Saw, suitable for cutting “ Plastic “
5. Electric Drill Motor, to drill concrete and steel (hammer and conventional)
6. 4” hole saw (Required for adding Outlets in the field)
7. 3/8” masonry bit 8” minimum length (required for mounting rails)
8. 1/4” masonry bit 6” minimum length (required for mounting rails)
9. 1/4” steel bit 6” minimum length
10. Counter sink metal drill bit
11. Jig saw w/metal blades (see Picture 2 – 3)
12. Broom & Shop Type / Regular Vacuum cleaner
13. Tape measure or stick ruler
14. Rubber mallet
15. Carpet knife w/razor blades (see Picture 2-4)
16. Carpenter’s Framing Square (one side at least 24”)
17. Putty knife (optional for use in removing panels)
18. Screwdrivers (standard – large) (Phillips – very small)
19. Ratchet with 4” extension and socket to fit bolt anchors
20. Extension cord
21. Scissors (optional for trimming carpet cuts)
22. Goggles
23. First aid kit
24. Calking gun (for adhesives when required, transition molding / ramps)
25. Knee Pads
26. Labeling machine w/batteries & labeling tape or Label Numbers
(see Picture 2-5)

Please Note !!!

Labeling of communication cables and outlets is a project specific requirement. Labeling may not be required at all (Client will test cabling & label after the install is complete). The project may require a simple unique number be applied to each end of the cables, or may require a specific alpha / numeric identifiers consistent with the client’s network standards.

You should determine this requirement in advance of the installation.

Picture 2-1

Example 12" Band Saw



Picture 2-2

Example Miter Chop Saw & Blade



Picture 2-3

Jig Saw & Blades



Please Note !!!

The jig saw MUST have blades long enough to cut through material 3" thick in a single pass.

Picture 2-4

Standard Carpet Knife



Picture 2-5

Example Labeling Machine and Peel & Stick Numbers for Data Cables



SUPPLY REQUIREMENTS

The following items are consumables and may not be required for every project. As projects vary and change these items are highly recommended to have on hand at all times.

1. ¼" x 2 ½" toggle bolts
2. ¼" x 1" wall anchor
3. ¼" x 1" screws
4. 3/8" x 2 ½" bolt anchors
5. 4 ½" x ¼" and 2 ½" x ¼" sleeve anchors
6. Nail anchors
7. Washers for ¼" screw
8. Concrete Floor Patch Material (Flash Patch)
9. Roll of duck tape
10. 1" paint brush
11. Contact adhesive (1 pt)
12. Colored electrical tape for power cables (at least 5 different colors)
13. Permanent marking ink pins
14. 8" tie wraps
15. Black magic marker
16. Black spray paint
17. Trash bags

PRODUCT RECEIVING & STAGING PROCEDURES

- 1) Upon arrival at the installation site, insure that the location of the installation is ready to receive the FFIT Floor system. It is highly recommended all construction phases be complete prior to installing FFIT Floor. Sometimes this just cannot happen, however, at a minimum, if new walls are being built in the area. The drywall must be installed (not just the studs) so the FFIT Floor can be cut to fit and the floor secured in place.
- 2) Determine the location the FFIT Floor products are to be staged and the best route from the place of unloading to the staging area. The product should be staged in the area where it is to be installed and on the opposite side of the room where the installation will begin. The project shop drawing will show the starting point of the floor panels (see " X " marked panel). If this is not possible, stage the product as close to the installation room as possible.
- 3) Unload and prepare the equipment to move the product to the staging area. It is recommended the product be left on pallets when moved to the install area or room. This will cut down on labor and time. If you must take the product off the pallets in order to move, dollies and commercial bins are recommended.
- 4) Upon arrival of the product, unload the product and get the truck ready for departure in the most expeditious manner as possible.
- 5) Confirm pallet count and inspect the product for damage. Any visual damage should be noted on the bill of lading and reported as soon as possible. Any missing pallets should be reported immediately and noted on the bill of lading.
- 6) Sign off on the shipping paperwork and retain one copy.
- 7) Move the product to the staging area, separate and stage like items together for easy access. (see Pictures 3-1, 3-2, & 3-3). The foam and whole panels are the items required first to begin the installation. Perimeters, loose pedestals, and pre-glued carpet tiles will be required next as the floor is cut in at the edges. Ramps and Rails will be required to finalize the floor structure installation. All electrical and communication components are required last.
- 8) Secure product and secure all equipment.

Picture 3-1 Receiving and Staging Procedures



Picture 3-2 Receiving and Staging Procedures



Picture 3-3 Receiving and Staging Procedures



SUB-FLOOR INSPECTION & PREPARATION

- 1) It is advisable to briefly inspect the entire area where the system is to be installed. Comparing general wall locations with the drawing, confirming overall dimensions, door locations, etc. It is also advisable to be aware of any low ceiling height areas you are adding three inches of height with the FFIT Floor system.
- 2) The client has been advised that the FFIT Floor system requires a smooth sub-floor surface. Closely inspect any sub-floor areas that have cracks, holes or sunken areas, which would prevent the installation. Specific holes or uneven slab joints may require flash patching. Also look for other minor protrusions or obstructions, which may require scraping or grinding. Do not confuse these conditions with the overall levelness of the sub-floor. Any condition that would prevent the panels from setting firmly and evenly on the sub-floor would need to be addressed. If these conditions are minimal, it is advisable to correct them as part of the installation. If they are excessive, they need to be addressed with the client.
- 3) Also check for excessive moisture or water standing on the installation site. The FFIT Floor system should not be installed if these conditions exist.
- 4) Insure you have completed walls to fit the FFIT Floor system against, at all system termination edges. If construction is underway, and a wall is being built, you must, as a minimum, have the studs covered with drywall or finish surface material. You cannot install FFIT Floor against exposed studs; except for planned applications of this type.
- 5) Insure that all structures, pipes, drains or other obstacles that are protruding up through the system flooring are shown on the project drawing. These items require the appropriate flooring components for cut to fit, in the field, application.
- 6) Sweep and remove all dust and dirt, from the floor. Insure all wall plaster or similar left over construction debris has been removed. (see Picture 4-1)

Picture 4-1

Sub-Floor Inspection



Typically carpet glue residue is not a concern.



INSTALLING FOAM UNDERLAY

- 1) The Volara foam padding will be laid on all surfaces where the FFIT Floor system is to be installed. The foam may be either white or charcoal grey in color. Its color has no meaning.
- 2) The padding has two purposes. First, the foam cushions the panels and prevents clicking on hard surface sub-flooring. Second, the panel pedestal legs mark the foam to make it easier for power and data cabling to be installed.
- 3) The foam will be laid in a manner that allows the entire floor surface to be covered. It is very important to lay the foam close to all walls and columns, etc. The reason for this close fit is to give the same cushion and shim base as the rest of the floor. This will allow the carpet on the trim work to have a smooth and even fit. The foam must not be allowed to overlap, as it will cause a rise in the panel.
- 4) Panels can be used to hold the foam in place, while it is being rolled out and cut. As the foam is being rolled out, it is helpful to "spot tape" the seams between two pieces (duck or masking tape can be used). It is acceptable, but not necessary to tape the entire seam. The goal is simply to hold the foam in place with a "butt seam" until the panels can be placed on top of it.
- 5) It is advisable to lay the foam just in front of those areas where you are placing floor panels, and avoid laying the foam in a whole room first, then placing the panels. This will help prevent debris and dirt development on top of the foam, or damage to the foam. (see Picture 5-1 & 5-2)
- 6) Foam will not be laid on areas where system floor components are not being used such as under ramps, rails and Z trim.

Picture 5-1

Installing Foam Underlay



Picture 5-2

Installing Foam Underlay



PANEL LAYOUT & INSTALLATION

- 1) The starting point for laying the panels is predetermined and shown on the drawing with an "X". (see Detail Plan P - Detail P1). Each square shown on the shop drawing represents a floor panel.

The Floor Panel size is based on the carpet tile specified by the client. FFIT Floor provides floor panels in two sizes, 18" x 18" or 50 cm x 50 cm, both are nominally 3" high overall including the carpet.

Please Note !!! Written instructions and photos herein show the 18" size panels and components. There is no functional difference between the components of the two different sizes, but where appropriate both are shown.











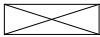
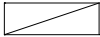

- 2) The carpet tile grain direction is also predetermined and shown on the drawing for laying the panels, (see Detail Plan P – Detail P2). The carpet tile grain is also indicated on each panel as a yellow / white arrowhead marked on the legs. (see Picture 6-1)
- 3) When it is possible, the starting point will be in a corner where a right angle is formed. If the drawing indicates such a starting point, check the correctness of the right angle, as it is very important to get the floor panels started correctly. This will help keep the panels square and make a tight fitting application. This is most easily accomplished by setting 5 or 6 panels out from the corner in both directions, filling in the area forming a triangle and checking to make sure the panel corners stay aligned.
- 4) In some installations an unobstructed, right angle corner does not exist, and the full panel starting position is other than in a corner. In these cases, it is necessary for the first panel to be located on a wall, beyond the junction of an intersecting wall and the obstruction. Place the first full panel on one of the walls beyond the obstruction, at an 18" / 50 cm increment. Then place several additional panels, in both directions, back to the intersecting wall. Maintain the corner to corner alignment as shown on the drawing (see Picture 6-2). Field cut to fit pieces are then used to fill in around the obstruction in the corner area.
- 5) It is important to have all rows of panels placed to meet firmly and stay aligned corner to corner throughout the entire floor. As you lay the floor around obstacles, keep the panels corner to corner and fill in around the obstacle with field cut perimeter components. (see Picture 6-3)
- 6) Panel tightness must be maintained throughout the panel placement process. No gaps should occur between panels and the carpet tiles should show as tight seams. Panel components are sized and assembled to provide a 1/16" overhang of the carpet tile on all four sides of the panels to assure carpet tile to tile seams.
- 7) All panels with ports for Electrical and Communication outlets will be placed in the same location as shown on the drawing. Please note that panels with outlet port or ports, are fully explained later in this section.

Section 6

Detail Plan P

Blow Up A / General Installation Notes

1. INSTALLATION CONTRACTOR WILL BE RESPONSIBLE FOR COORDINATING THE STAGING AREA FOR FFIT FLOOR AND INSPECTING CARPET PANELS FOR VISIBLE DEFECTS PRIOR TO INSTALLATION.
2. THE FLOOR MUST BE FREE FROM ALL PROTRUDING OBJECTS, FOREIGN MATTER, DIRT, CRACKS, HOLES, AND DEPRESSIONS. OBVIOUS DEFECTS MUST BE REPAIRED BEFORE INSTALLING FFIT FLOOR.
3. INCREMENTAL OUT OF LEVEL FLOOR CONDITION SHALL BE 1/8 INCHES IN ANY 10 FEET, AS MEASURED WITH A STRAIGHTEDGE.
4. INSTALL FOAM SHEETING OVER THE EXISTING SUBFLOOR BEFORE LAYING FFIT FLOOR PANELS. FOAM EDGES SHOULD NOT BE ALLOWED TO OVERLAP. REFER TO FFIT FLOOR INSTALLATION MANUAL FOR ADDITIONAL DETAILS.
5. CONTRACTOR WILL BE RESPONSIBLE FOR FIELD VERIFYING ALL DIMENSIONS ON THE JOB SITE TO ENSURE AN ACCURATE INSTALLATION. PRINT DIMENSIONS ARE TO BE USED FOR REFERENCE ONLY.
6. YELLOW / WHITE ARROWS ARE PLACED ON THE SIDES OF EACH PANEL TO INDICATE CARPET PILE DIRECTION. ALIGN PANELS WITH ARROWS RUNNING IN THE SAME DIRECTION.
7. FFIT FLOOR INSTALLATIONS MUST CONFORM TO APPROPRIATE NATIONAL ELECTRICAL CODES, AS WELL AS, ANY STATE, CITY, COUNTY, OR LOCAL BUILDING CODE REQUIREMENTS. FFIT FLOOR WILL NOT BE RESPONSIBLE FOR ANY CODE VIOLATIONS RESULTING FROM MISUSE OR IMPROPER APPLICATION OF THE PRODUCT.
8. COMPETENT AND AUTHORIZED PERSONNEL SHOULD INSTALL THE FFIT FLOOR SYSTEM.
9. ANY ELECTRICAL WORKING DRAWINGS OR LAYOUTS MUST BE REVIEWED AND APPROVED BY A LICENSED PROFESSIONAL ELECTRICAL ENGINEER IN ACCORDANCE WITH APPROPRIATE FEDERAL AND STATE LAWS GOVERNING SUCH PRACTICES.
10. FFIT FLOOR RESERVES THE RIGHT TO MAKE PRODUCT REVISIONS AT ANY TIME WHICH MAY AFFECT LAYOUT METHODS AS STATED HEREIN. IF ANY QUESTIONS EXIST, CONTACT FFIT FLOOR PRIOR TO PERFORMING ANY LAYOUT WORK.
11. AMPINERGY MODULAR DISTRIBUTION SYSTEMS USED WITH FFIT FLOOR ARE APPROVED FOR INSTALLATION IN COMMERCIAL AND INDUSTRIAL LOCATIONS. THE SYSTEM COMPLIES WITH SECTION 604 OF THE NATIONAL ELECTRIC CODE, (REF: UL 183), REGARDING THE USES OF MANUFACTURING WIRING SYSTEMS.
12. ELECTRICAL TIE-IN FROM SINGLE ENDED CABLE ASSEMBLIES TO EXISTING BUILDING PANELBOARDS BY OTHERS. REFER TO AMPINERGY LINE ENTRY CABLE DETAIL ON THIS DRAWING FOR CIRCUIT WIRING SCHEMATIC.

POWERFLOR KEY	
	STARTING SOLID PANEL ARRAY
	POWERFLOR PANEL ASSY 18 X 18
	9-INCH PEDESTAL
	PERIMETER 6 X 9 CUT TO FIT
C	CARPET TILES APPLIED ON FLOOR
	PERIMETER 6 X 18
	PERIMETER 6 X 18 CUT TO FIT
	DATA INSTALLATION KIT/ RJ45 INSERTS & COVER
	DUPLEX CIRCUIT #1,2,3 OR 4
	DUPLEX CIRCUIT #1,2,3 OR 4 ISOLATED GRD.
	AMPINNERGY POWER CABLE ASSY.
	CAT5 TEL/DATA CABLE-UTP
	GROMMET 4"
	AMPINNERGY JUNCTION BOX UNDER FLOOR
38	AMPINNERGY POWER CABLE LENGTH
96S	SINGLE ENDED POWER/LINE ENTRY CABLE
	OPEN POWERPORT WITH LID

Detail P-1 Starting Location

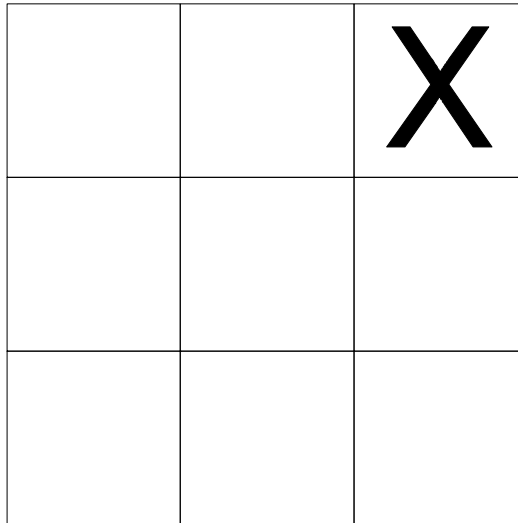

Detail P-2 All panels shall be placed with carpet grain direction as shown on drawing (above Red circle on sample).

CARPET DIRECTION



Picture 6-1 Full Panel (Showing Carpet Tile Direction)



Picture 6-2

Starting the System in a clear corner



When starting the System at a corner with an obstacle, use three whole panels to determine the area around the obstacle. Corner area needs to be filled with appropriate perimeter / pedestal components and cut in around the obstacle, to provide a firm starting point.



FIELD CUT
AS REQUIRED

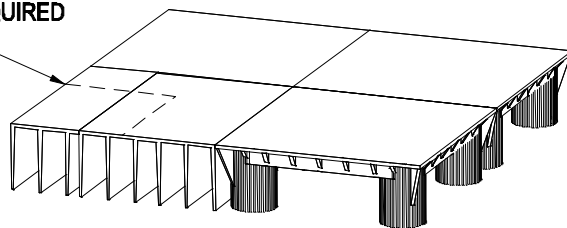

Picture 6-3

Installing the System around obstacles not in starting corner, maintain corner to corner alignment with whole panels and filling in open spaces with appropriate components.



An appropriate quantity of whole panels will be supplied with outlet ports installed into them, per the project drawing. These outlet locations are provided with a universal outlet grommet (**Powerport** grommet) which is used for the installation of either electrical or communication components.

During the floor structure installation, it is important to properly locate and place a panel with the appropriate Powerport grommet without being concerned as to its use (electrical or communication).

It is highly recommended.... while installing the whole floor panels, that you do not address outlets and their locations. Simply place all whole panels (with & without outlets) in place and cut in the edges.

It is more time effective to go back and rearrange the panels with outlets to their correct locations, after the floor structure is complete !!!



[above picture shows system installed on existing carpet]

The most time effective means and procedure for panel placement is to place the panels working out and away from the starting corner. Do so working out the perpendicular walls equally, filling in between at a 45 degree angle, pushing all panels tightly into the corner. Panels can be staged via carts or hand loaded piles just ahead of the placement line.

This process allows you to consistently watch to see if the walls are forcing the panels out of alignment. It is not uncommon for the walls to force the panels out and back into alignment, this is acceptable up to ¼". If alignment continues to run out, you need to go back and address.

Care should be taken when pushing the panels into place to maintain tightness. This is best accomplished using a short 2" x 4" and a rubber mallet or kicking the top surface of the carpeted panel.

Do not kick edge of panel as damage to the carpet will occur....

Correct !!!!



Wrong !!!!



OUTLET PANELS - Each whole panel can have an outlet in each corner quadrant of the panel, or any combination of quadrants. The outlet locations are identified as an outlet position 1 thru 4, in consideration of the carpet grain direction. Outlet positions are as shown here.....

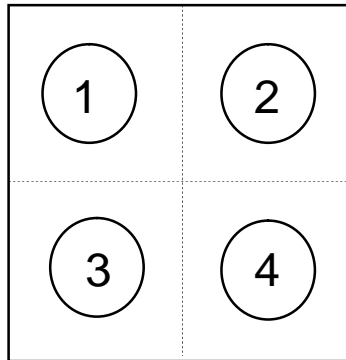

CARPET DIRECTION



To properly locate the outlets in the floor structure you must review the shop drawing, locate each outlet, identify which outlet position / positions are required for that location and place the appropriate panel in that location. The shop drawing does not indicate the “ Powerport “ position number.

Please Note !!!

Panels can have more than one outlet in them and they will be appropriately marked. For example a panel marked “ 23 ” will have outlets located in the number 2 and 3 positions.

Picture 6-4

Panel with Port in # 1 position



Picture 6-5

Panels with Port in # 2, # 3, & # 4 positions



Picture 6-6

Remove Solid Panel from System

Using a putty knife or similar thin blade tool, slide into seam and pry upwards.



Picture 6-7

Replace with correct Outlet Panel

Confirm correct outlet location on drawing based on carpet grain direction and outlet Number.



Please Note !!!

The process of locating the panels with outlets after the floor has been installed is a recommendation, as it saves installation time.

Care should be taken if this process is being done while the edges are still being cut in, as while panels are out of the floor, it is difficult to make sure that all panels are pushed tightly together (no gaps) for an accurate cutting dimension at the wall.

INSTALLING PERIMETER

- 1) Perimeter components are used to fill in all spaces where an 18" x 18" or 50 cm x 50 cm panel is too large to fit.
- 2) There are two types of components used to fill in edge spaces, loose pedestals and ribbed components called Perimeters. The loose pedestals are sized to the panel size of the project, for 18" panels, 9" x 9" loose pedestals will be provided, for 50 cm panels, 25 cm x 25 cm loose pedestals will be provided. Only the ribbed components are intended for cutting to size in the field. Perimeters are 6" x 18" for use with 18" panels and 25 cm x 25 cm for use with the 50 cm panels. (see Pictures 7-1, 7-2, & 7-3)
- 3) Some areas may require multiple ribbed Perimeter components or loose pedestals, while other areas may require a combination of both. (see Detail Plan P – Details P-3, P-4, & P-5).

These Details are meant to illustrate the completed perimeter assembly. Perimeter components are to be cut to fit as individual components, to assure snugness of fit.

- 4) All perimeter components are provided without the carpet tile attached. Pre-Glued carpet tiles are provided for installation on these components, after they are cut and fitted into the space. This will assure a proper carpet tile installation.
- 5) When you have small areas that require perimeter, it must be cut to a custom fit. When you have areas less than one and one eighth inch (1 1/8") to be filled, the ribbed component should not be cut lengthwise with the rib. It must be cut perpendicular to the rib, to provide stability when installed. The perimeters can also be cut to fit around cornered obstacles. (see Pictures 7-4, 7-5, & 7-6)
- 6) All areas requiring perimeter to be cut, will be cut to fit snug. It should not be so loose it leaves gaps nor should it be so tight it requires extreme force to insert. The perimeter is used as a base for the carpet and helps to hold the panels in place. (see Pictures 7-7 & 7-8)

Picture 7-1

Loose 9" x 9" Pedestal



Loose 25 cm x 25 cm Pedestal



Picture 7-2

6" x 18" Perimeter (Top View)



(Bottom View)

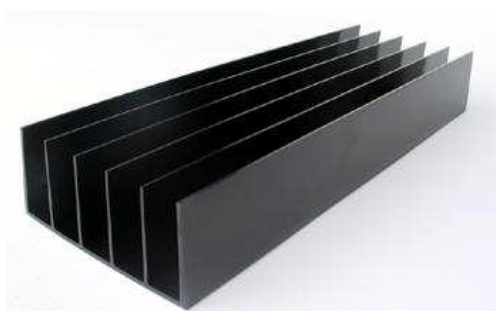

Picture 7-3

25 cm x 25 cm Perimeter (Top View)

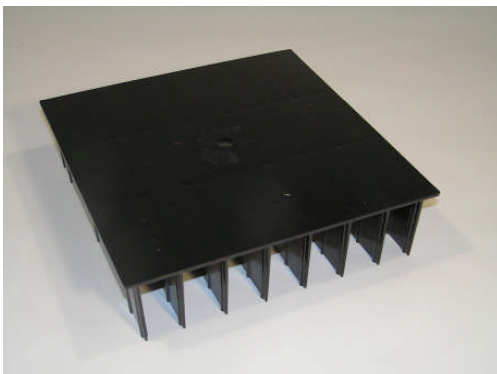

(Bottom View)

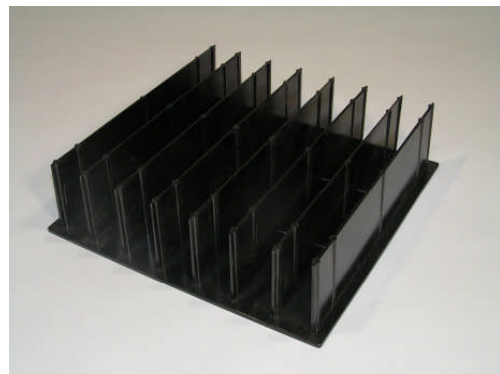

Detail P-3

Panel with combination of perimeter / pedestals

**FIELD CUT
AS REQUIRED**

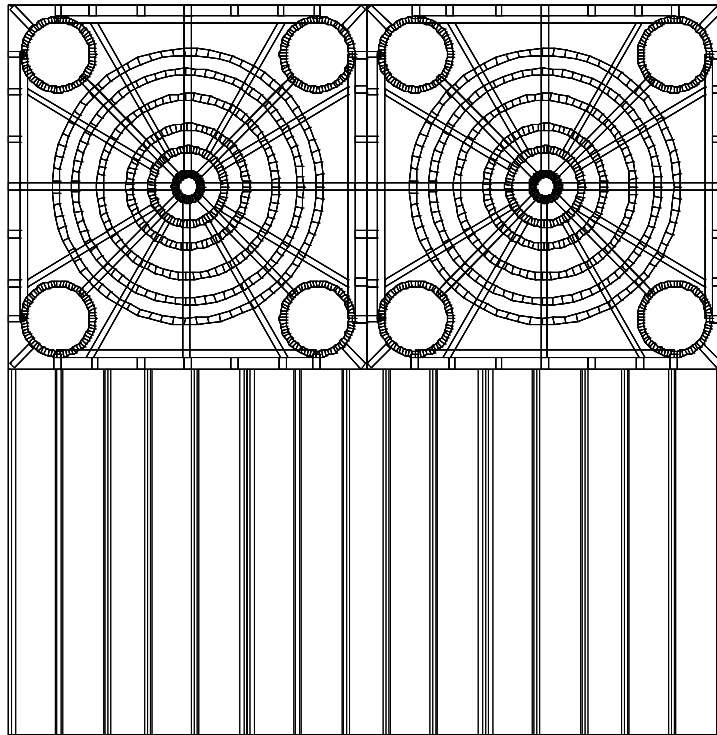
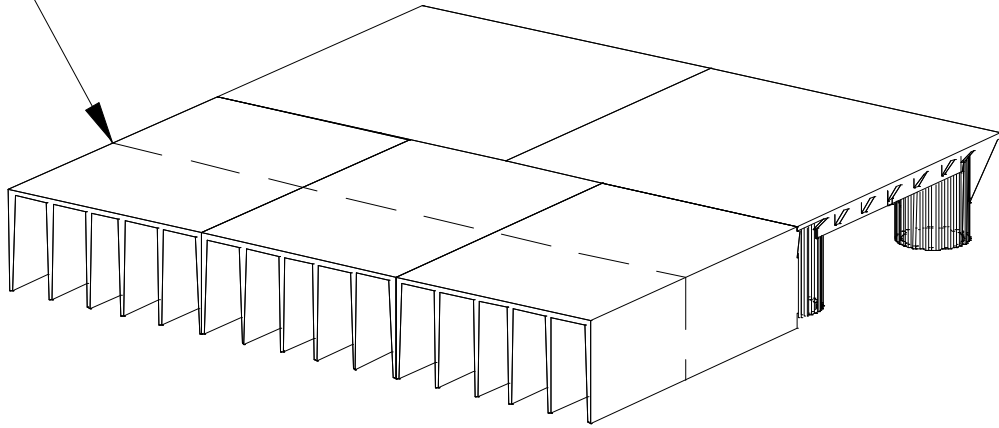

Detail P-4

Panel with combination of perimeter / pedestals

FIELD CUT
AS REQUIRED

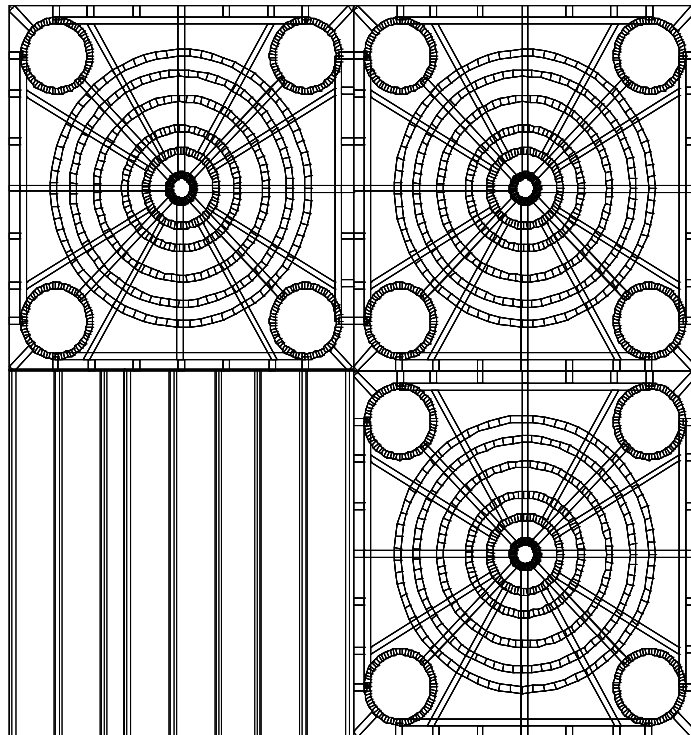
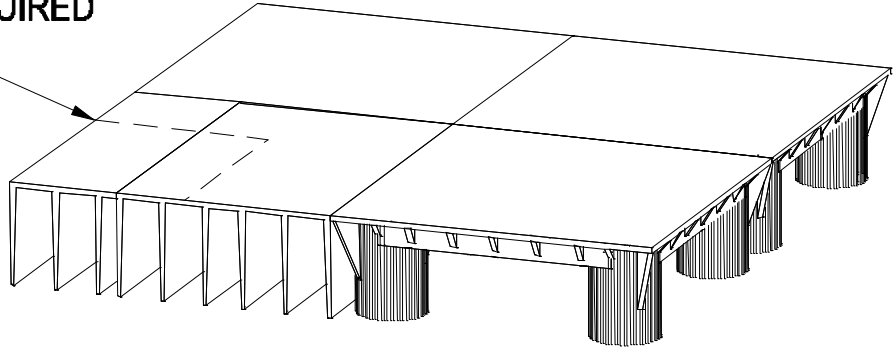

Detail P-5

Panel with perimeters only

**FIELD CUT
AS REQUIRED**

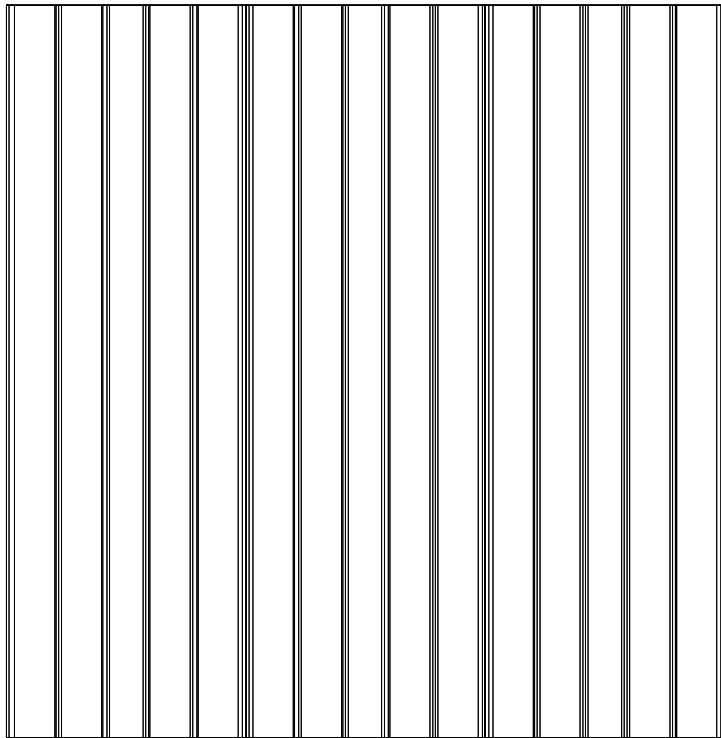
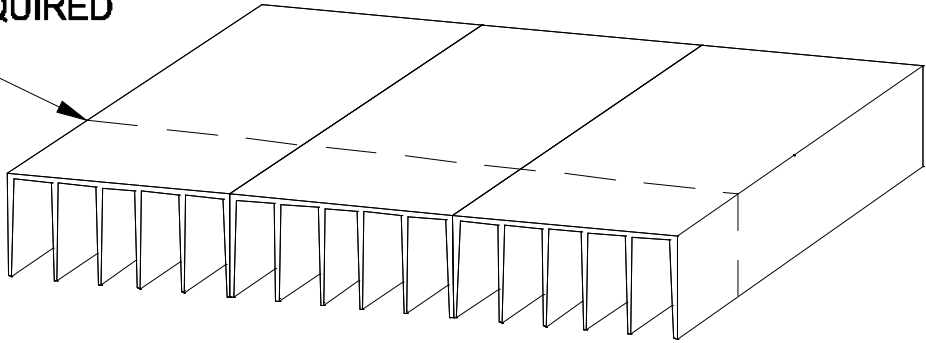

**Picture 7-4
Cutting Perimeter**



**Picture 7-5
Cutting Perimeter**



Picture 7-6 Cutting Perimeter



Picture 7-7 Filling In Perimeter around obstacles



Picture 7-8 Filling in Perimeter around obstacles



INSTALLING CARPET ON PERIMETER

- 1) Carpet will be field cut to cover the perimeter that has been installed.
- 2) All carpet cut for trim work must maintain directional integrity as shown on the drawing. Please see back of loose carpet tiles for an imprinted carpet direction arrow.
- 3) The carpet will be cut to provide a snug fit between the adjacent full panels and the wall or obstacle which you are trimming out to. It should not show any gaps, nor should it have to be forced into place.
- 4) When trimming you must maintain seam integrity of factory edge to factory edge, in both directions. All field cut edges should be made, to be located around obstructions, walls, and / or rails.
- 5) Loose pre-glued carpet tiles are provided for this procedure. These carpet tiles are provided with a protective waxed paper backing, which is removed and discarded, after cutting, and immediately prior to applying the tile to the perimeter components.
- 6) Working with the carpet tile, upside down and in place, is advisable, for the cutting procedure. This provides the most accurate templateing and assures the proper fit. When cutting is complete, remove the waxed paper backing, flip the carpet tile over, and all field cut edges are against the item being trimmed to. (see Pictures 7-9, 7-10, & 7-11)

Please Note !!!

In some cases, the FFIT Floor system is provided using a permanent adhesive. When a PVC hard-backed carpet tile has been used, providing pre-glued carpet tiles is impossible. Applying the adhesive to the carpet tile for this procedure is done in the field, and un-glued carpet tiles are provided for this purpose.

- 1) Carpet will be field cut as described above prior to applying the glue.
- 2) All carpet cut for trim work is as described above, maintaining carpet tile grain directional integrity, seam integrity of factory edge to factory edge, and cut to provide a snug fit between the adjacent full panels and the wall or obstacle.
- 3) After the carpet tile has been cut to fit, it should be placed on a protected surface upside down, where glue is applied sprayed or brushed, per project spec.
- 4) The glue is a contact cement type glue, so it must be applied to both the back of the carpet tile and the top surface of the perimeters being covered. The containers of glue provided will provide instructions for application, drying time, and application instructions.
- 5) Care should be taken to assure that glue application is done in a good workmanlike manner, without glue getting on carpet tile face or adjacent areas.

Picture 7-9

Cutting carpet tile for perimeter



Picture 7-10

Cutting carpet tile for perimeter



Picture 7-11

Installing carpet tile on perimeter



Please Note !!! All cut carpet tiles should be placed so that the factory edges (not cut edges) adjoin the factory edges of adjoining tiles. Cut edges are always placed against walls, rail bases, Z Trim, etc.)

INSTALLING Z TRIM

- 1) In some instances it is required to end the FFIT Floor system without a wall or other fixed building structure to act as a barrier. In these cases Z Trim is used. (see Pictures 7-12 & 7-13)
- 2) The Z Trim will be custom cut to fit the opening where it is to be installed. (see Picture 7-14) Z Trim is meant to be glued, anchored with sleeve anchors, nail anchors, or flush screwed to the sub-floor and provides a vertical edge to the system which laps over the top of the system's edge components. (see Detail P-6)
- 3) When installed, FFIT Floor components fit into and underneath the top flange of the Z Trim on one side and carpeting is to be installed on top of the floor attachment flange. Floor attachment must be accomplished in as flush a manner as possible, so that the carpeting over is unobstructed.

Please Note ! Carpeting beyond the FFIT Floor system may or may not be included, so the installation of the carpeting that covers the floor attachment flange may or may not be part of your work scope. Check install agreement and project drawing for clarification.

- 4) Z Trim is used to brace and dress FFIT Floor edging along doorways and obstacles such as sliding walls, etc., where no permanent building structure exists. Z Trim is commonly used in doorways to supply rooms, communication rooms or similar joining spaces where FFIT Floor is not installed and ramps are not used. Z Trim is also used to dress ramp edges where a rail is not used or to end the system along other non-fixed building elements (i.e. Sliding Marker / Chalk boards, see Picture 7-15)
- 5) When Z Trim is used at doorways where ramping is not desired (see Pictures 7-16, 7-17, & 7-18) it must be installed in a manner that allows for the proper operation of the door. When door is closed, Z trim is to be located underneath the door.

Picture 7-12

Z Trim (as provided)

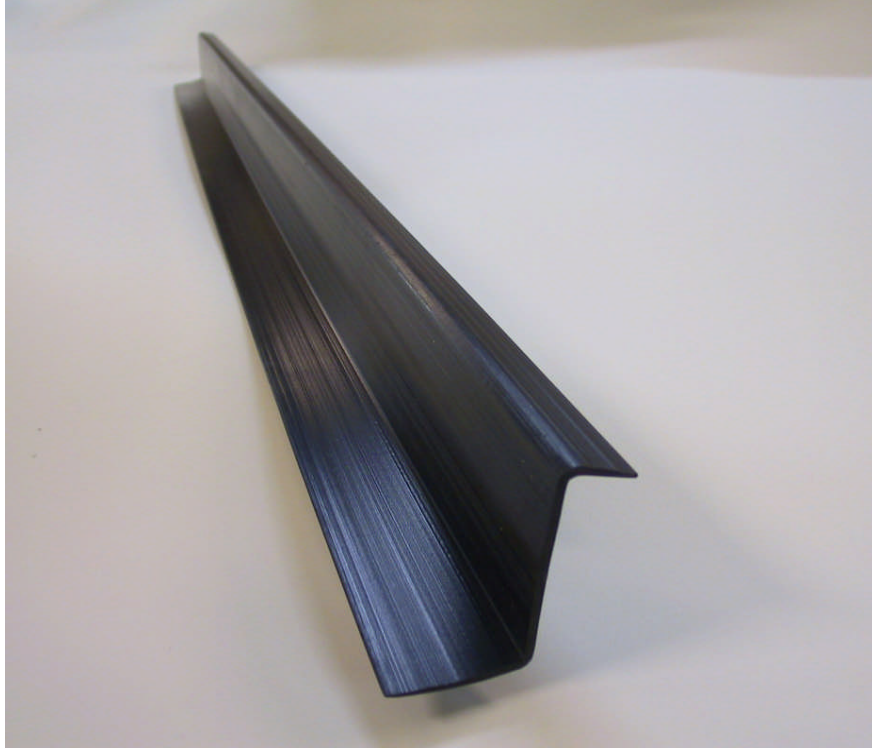

Picture 7-13

Z Trim installed at the edge of the system



Detail P-6

Detail of Z Trim with panels

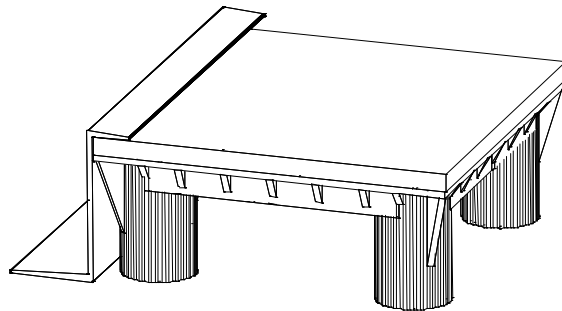
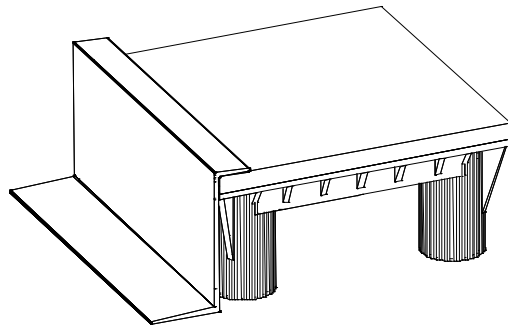
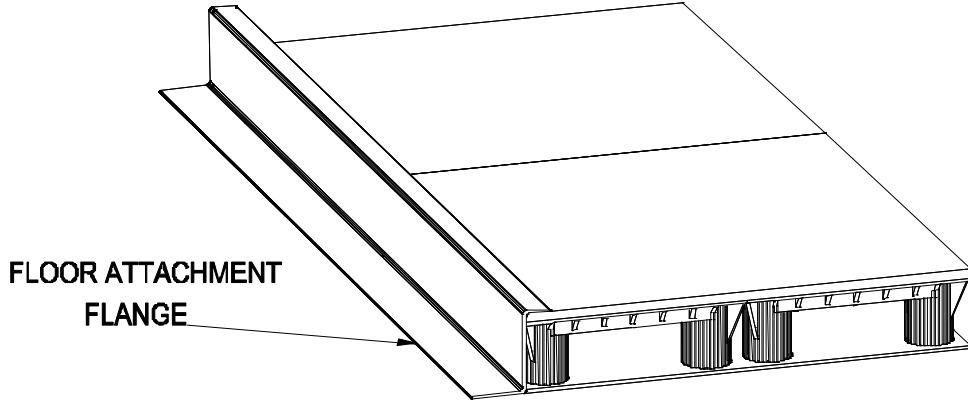

Picture 7-14 **Cutting Z Trim**



Picture 7-15 **Z Trim Installed**



Picture 7-16

Z Trim in a doorway



Picture 7-17

Z Trim in a doorway



Picture 7-18

Z Trim / Perimeters in a doorway

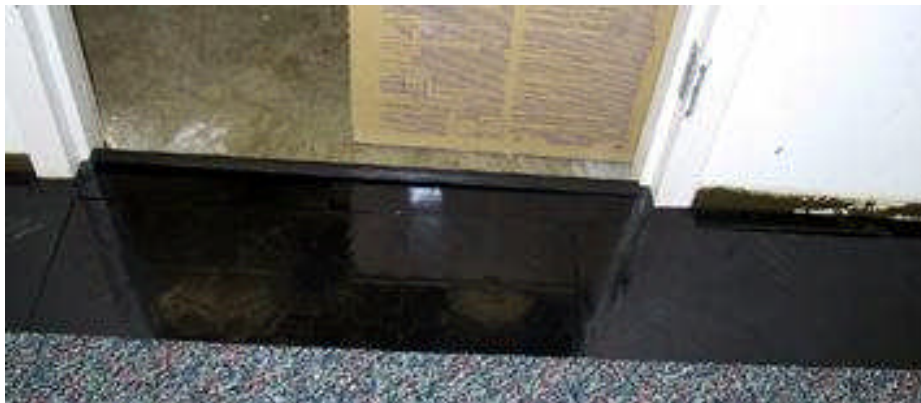

INSTALLING RAMPS & RAILINGS

RAMP INSTALLATION

- 1) The FFIT Floor system is provided with ramps for pedestrian access. These ramps are available in three different slopes.
- 2) The 1/6 slope ramp is provided as a black polycarbonate unit, 18" wide by 18" long. This ramp unit does not meet ADA codes.
- 3) The 1/12 slope ramp is 35" long and the 1/20 slope ramp is 54" long. Both the 1/12 and 1/20 sloped ramps are constructed from steel and provided in widths, to meet the project requirements. Both of these ramp units meet ADA codes.
- 4) Ramp installations, may be provided as a single unit or multiple ramp units to achieve the desired overall width of the ramp access. The ramp size and type is predetermined and shown on the project drawing.
- 5) Once the ramps are located and positioned, they shall be anchored in place using ¼" x 3" sleeve anchors in such a way that the ramp will not produce a hollow sound when walked upon. (see Picture 8-1) Additional anchors may be required to tighten the ramp at any number of locations, to prevent " oil canning " .
- 6) When drilling holes, make sure they are counter sunk and the anchors do not interfere with the laying of carpet tiles. (see Picture 8-2)
- 7) In some instances a ramp unit may have to be field cut or small fillers added at the edges. This can occur when the ramp is to be installed between building structures (i.e. walls) that are not parallel and / or straight. When cutting the ramp width, care should be taken to locate the cut or cuts to provide maximum support (i.e. as close to the web supports as possible). If fillers are required or additional support to a cut ramp, this can be accomplished using wood fillers, cut appropriately.

Picture 8-1

One Piece Ramp Installed with Rail and Z Trim



Please Note !!!

Care should be taken to place the ramp / ramps as shown on the shop drawing to assure compliance with ADA recommendations, where required.

Wheel Chair Turnaround Area

Two Piece Ramp Installed - between a wall and a Rail



Picture 8-2

Drilling Ramp for countersunk anchors



Countersinking the anchors used for mounting the ramps, eliminates any bulging in the carpet tile, placed on the ramp.

RAILING INSTALLATION

- 1) Ramp access to the system can be provided in a vast assortment of configurations, depending upon site conditions and client requirements. In most instances, a rail is specified next to ramps and around ramp access areas, to prevent unfinished system edges and to eliminate any tripping hazard.
- 2) Ramp access areas and the rail layout associated with these areas are predetermined and shown on the project drawing.
- 3) Rails are provided in a standard height, with a base that accepts the FFIT Floor system on one side and provides a finish edge on the other side. All standard rails are provided powder coated paint finish, black in color. (see Picture 8-3)
- 4) Rails are provided in two widths, 24" and 36". These units can be used as stand alone rails or configured in multiples to serve many different layout requirements. In rare cases, rails have to be cut to meet field conditions. When required the shop drawing will detail and the cut should be done so cut end is against the wall.
- 5) All rail units can be mounted end to end, in a straight line or at right angles to one another. This is accomplished with a 1/4" – 20 nut & bolt (provided by FFIT Floor), which is placed through the holes in the rail top caps. (see Pictures 8-4 & 8-5). Or they can be mounted to a wall by using a wall bracket (see Pictures 8-6 & 8-7).
- 6) All rail units are bolted to the sub-floor. When mounting the rail to the sub-floor, use 3/8" x 2-1/2" bolt anchors with a washer and nut. If concrete slab use same sized concrete expansion bolts (see Picture 8-8). Perimeter units are used to fill in around rail base curbs on the system side of the rail. Curb is same height so carpet will cover top of rail curb.
- 7) When mounting the wall bracket, adjust your anchoring procedures according to the type of material you are anchoring to. If the wall is concrete or masonry block you will need to drill the wall and insert either a lead or plastic anchor. Then the wall bracket will be attached using a cap head screw / lag. If the wall is drywall, drill the wall and attach the wall bracket with a 1/4" x 2" toggle bolt and washer. If the wall is wood, use a cap head screw.
- 8) Insure the rail is plumb and shimmed to the wall if necessary.
- 9) The rail installation is completed by inserting the plastic filler covers in all rail top cap holes not used or visible (see Picture 8-9). All visible mounting hardware should be touched up with black paint or markers.

Picture 8-3

Rails located next to ramp



Rails configured at angles to provide ADA Wheelchair Turnaround

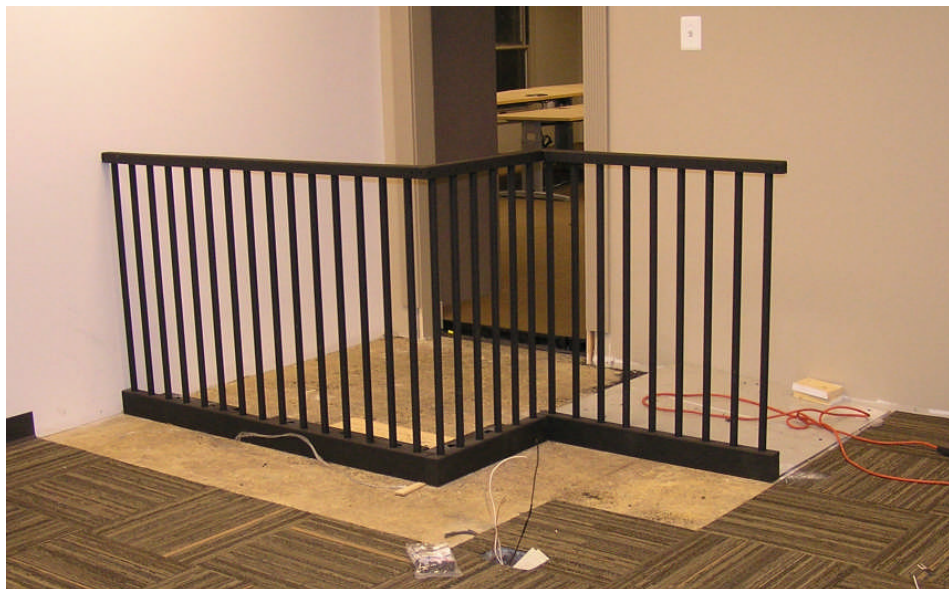

Picture 8-4

Rail Top Cap Connection Holes and Plugs



Picture 8-5

Straight / Angled Connections



Bolt is placed through the appropriate holes of the rail top cap, from the underside, and tightened.



Bottom of Rail Top Cap

Picture 8-6

Rail Wall Bracket



Picture 8-7

Rail Top Cap Hooks on Wall Bracket

Top Cap is open on the bottom



and slides down to a firm fit over the wall bracket



Picture 8-8 Rail anchored to floor with 2½" x 3/8" anchor bolt



Picture 8-9 Rail Top Cap Holes are filled with Plugs



INSTALLING CARPET ON RAMPS & AROUND RAILS

- 1) Carpet will be field cut to cover the ramp unit, the rail base curb, and the sub-floor area approaching the ramp as per the project drawing.
- 2) All carpet cut for trim work must maintain directional integrity as shown on the drawing. Please see back of loose pre-glued carpet tiles for a carpet direction arrow.
- 3) The carpet will be cut to provide a snug fit between the adjacent full panels and the rail base. (see Picture 8-10) It should not show any gaps, nor should it have to be forced into place.
- 4) When trimming you must maintain seam integrity of factory edge to factory edge, in both directions. All field cut edges should be made, to be located around rail base .
- 5) Loose pre-glued carpet tiles are provided for this procedure. These carpet tiles are provided with a protective waxed paper backing, which is removed and discarded, after cutting, and immediately prior to applying the tile to the ramp, rail base or sub-floor.
- 6) Whenever possible installation should be laid out so that a carpet seam does not occur at the top or bottom of ramp unit. Carpet tile seams will appear open if not made in the same plane. (see Picture 8-11)
- 7) Wherever the carpet tile ends, as per the project drawing, carpet should be terminated using a vinyl transition strip. These transition strips are provided and will provide a clean sharp transition between our carpet tiles and a hard surface floor. When our system adjoins other carpeting, the transition strip may not be used providing a clean and even transition from and onto the system.
- 8) The transition strip is a two piece unit and the base requires gluing and mechanical attachment to the sub-floor. The carpet tile is installed up to the mounting channel. And the finish strip clicks into the channel. (see Pictures 8-12, 8-13, & 8-14)
- 9) In all cases care should be used in providing a clean straight transition between the FFIT Floor system and all adjacent sub-floor areas.
(see Pictures 8-15, 8-16, & 8-17)

Picture 8-10

Trimming carpet tile around the rail and on the ramp



Picture 8-11

Carpet Tile seam installed beyond top and bottom of ramp



Picture 8-12

Transition Molding as provided



Picture 8-13

Transition molding with Carpet Tile

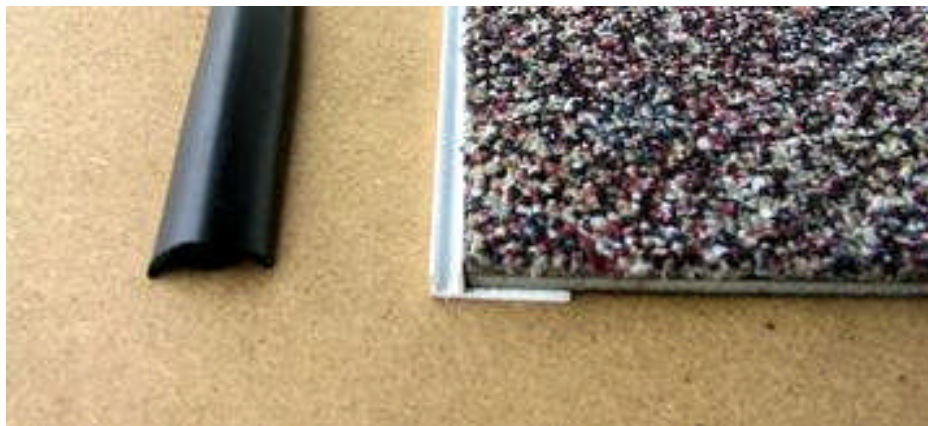

Picture 8-14

Transition Molding completed

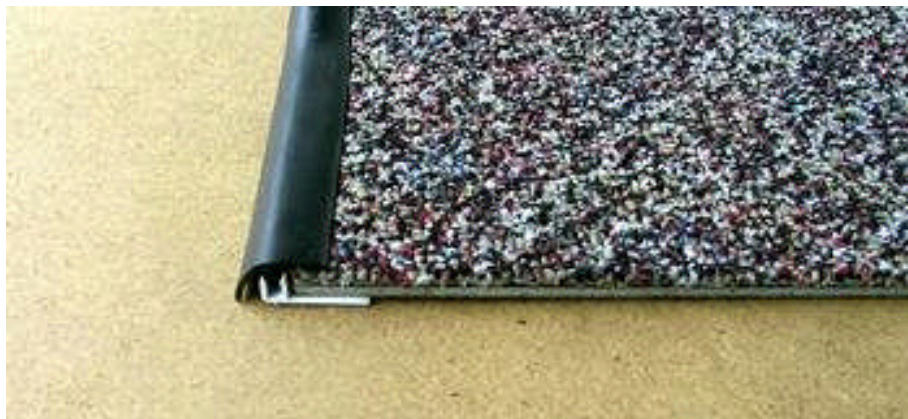

Picture 8-15

Installed Transition Molding



Picture 8-16

Installed Transition Molding



Picture 8-17

Completed Ramp / Rail Access

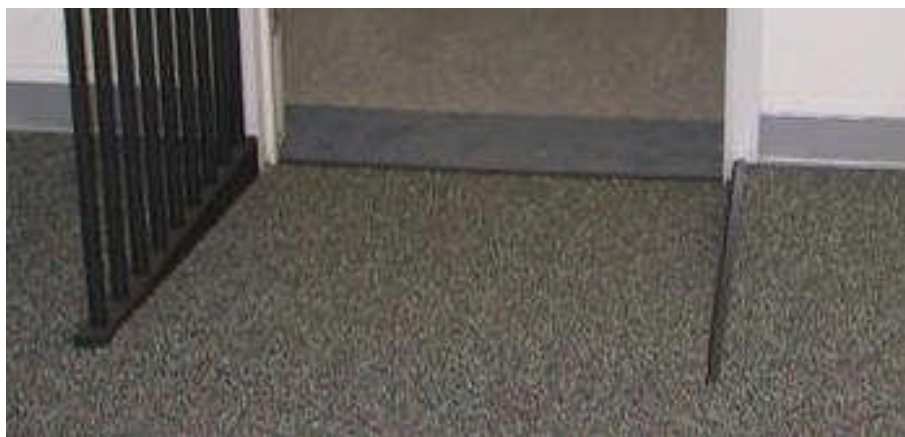

INSTALLING ELECTRICAL SYSTEM

- 1) The drawing will provide all the information necessary to install the electrical power system. (see Detail Plan E). The electrical system consists of 4 basic components, a power input cable assembly (varying lengths), double ended cable assembly (varying lengths), a Junction Block, and a Duplex Outlet Insert (provided for connection to one of the 4 circuits).
- 2) A licensed electrician should connect the power input cable assemblies, to the building power, as early in the installation as possible. This will allow for testing of the electrical system, prior to leaving the installation site. The input cable assembly should be connected, to allow a minimum of two feet of cable into the room, this to provide an easy connection of the double ended cable assemblies. Electrical connection to building power source is shown on drawing (see Detail E-1)

Please Note ! In many cases, the Power Input Cable assemblies are provided to the client in advance of the project shipment, so that they can be installed prior to the FFIT Floor installation. If this is the case, these items will not be part of the shipment you received.

- 3) Each power system leg will begin at the power input cable (Detail E-2) (see Picture 9-1) and will be connected directly to a double-ended eight-wire cable assembly (see Pictures 9-2 & 9-3) The cable length and location will be taken from the drawing. (see Detail E-3)
- 4) The double-ended cable assemblies will be connected to each other, end to end, using a junction block (see Picture 9-4) providing connections from outlet to outlet in the leg.

Please Note ! In some cases, a junction block is used as a cable assembly connector only, providing for the overall length of two cable assemblies, to reach a point. In these cases, no duplex insert is used and no mounting of the junction block into a powerport is done. The junction block simply lays under floor.

- 5) The duplex outlet insert number is located on the drawing (see Detail E 3) and on the insert itself. (see Picture 9-5) The duplex insert will be plugged into the eight-wire junction block (see Picture 9-6) by aligning the ground, neutral, and hot pins / tabs of the duplex inserts with the proper holes in the junction block, and pressing the insert down until it is securely attached to the junction block.
- 6) The junction block and duplex insert will be inserted into the bottom of a powerport grommet. (see Picture 9-7) The drawing will determine the powerport placement. After the outlet is snapped into the powerport, it will be held in place with a minimum of two powerport clips. (see Picture 9-8) Place the short end of the clip through one slot in the powerport bottom and the long end of the clip over the bottom of the junction block. Place the second clip on the opposite side and on the opposite end of the junction block in the same manner. (see Pictures 9-9 & 9-10)

- 7) The double-ended cable assemblies will plug into the Junction Block at one of four possible points (2 per end). Remove appropriate connection covers from the junction block ends. Make sure the male end of the key way on the cable is aligned with the female end groove of the junction block (see Picture 9-11) and press together until the locking clip on the junction block is securely latched. (see Picture 9-12)
- 8) Any of the four cable assembly plug locations on the ends of the junction block can be used to best provide for the cable placement beneath the floor structure. All junction blocks are connected to one another in a leg (daisy chain), as per the drawing.

Please Note !! The power layout may call for a junction block to have a cable assembly from the power source, connected to it, with more than one cable assembly connecting additional junction blocks. In this case extra care must be taken to assure that two power legs are not connected to each other in the system.

- 9) Each leg will be color coded with a different color, on location with colored tape. Apply tape at the end of the power input cable and on both ends of every double-ended cable. This should help prevent cross feeding the legs, when the customer relocates the outlets. (see Pictures 9-13, 9-14, & 9-15)
- 10) Once all electrical components are color coded, they can be assembled and mounted to the appropriate floor panels, progressing out each electrical leg. The floor panels are relocated back into the floor, locating the cable assemblies between the panel legs. (see Pictures 9-16 & 9-17)
- 11) If at all possible, test all electrical after installation and before leaving the installation site. This is usually accomplished by turning on the circuit feeds at the breaker and testing each circuit with an electrical tester or by simply operating an electrical tool from each outlet.

Detail E-1

Electrical connection to power source

AMPINNERGY LINE ENTRY CABLES

CONCEALED SINGLE-ENDED CABLE HARNESS INSTALLATION
FOUR (4) CIRCUITS, TWO (2) GROUNDS

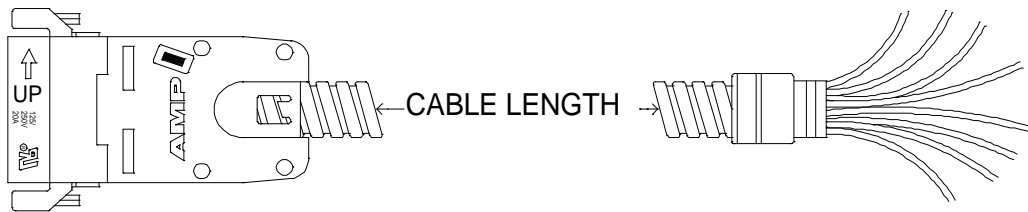

1	GREEN/BARE		GROUND
2	WHITE		NEUTRAL
3	GRAY		NEUTRAL 4
4	GREEN/YELLOW		ISOLATED GROUND
5	PINK		LINE 4
6	BLACK		LINE 1
7	RED		LINE 2
8	BLUE		LINE 3

Detail E-2

Drawing Detail Power Input Cable assembly

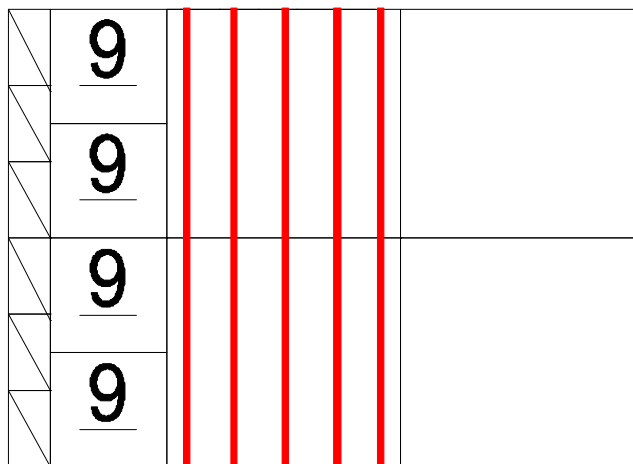

Detail E-3

Drawing Detail Cable Assm. & Outlet

CABLE LENGTH

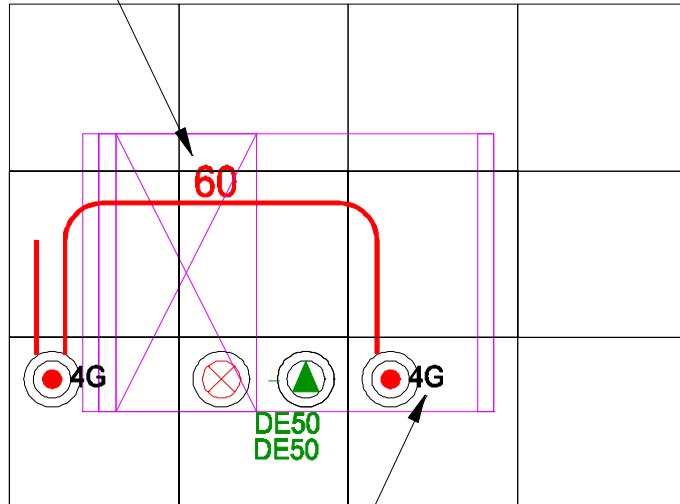

DUPLEX NUMBER

Picture 9-1

Single Ended Power Input Cable Assembly

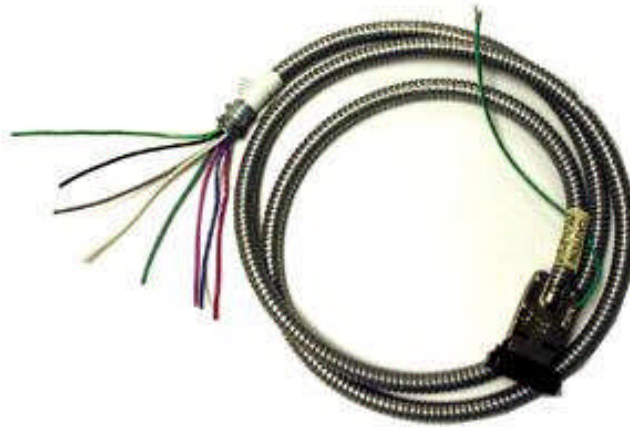

Picture 9-2

Double Ended Cable Assembly



Picture 9-3

Power Input and Double Ended Cable connected



Picture 9-4 Double Ended Cable Assembly connected with a Junction Block and mounted in Powerport grommet.



Picture 9-5 Duplex Outlet with Circuit Number

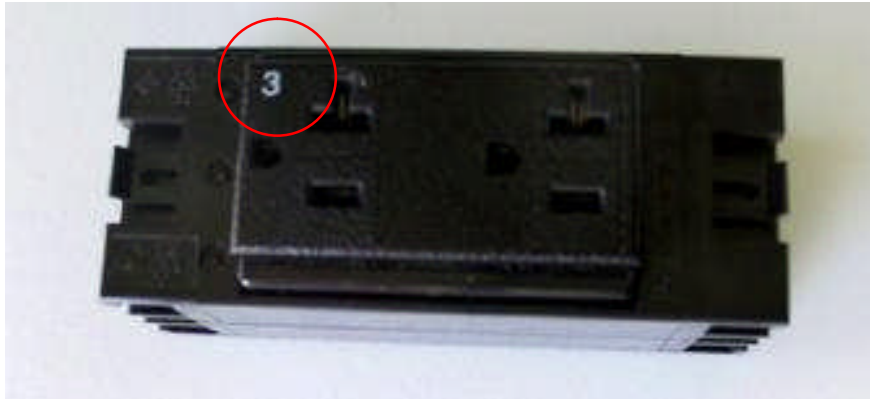

Picture 9-6 Installing Duplex Outlet Insert in Junction Block

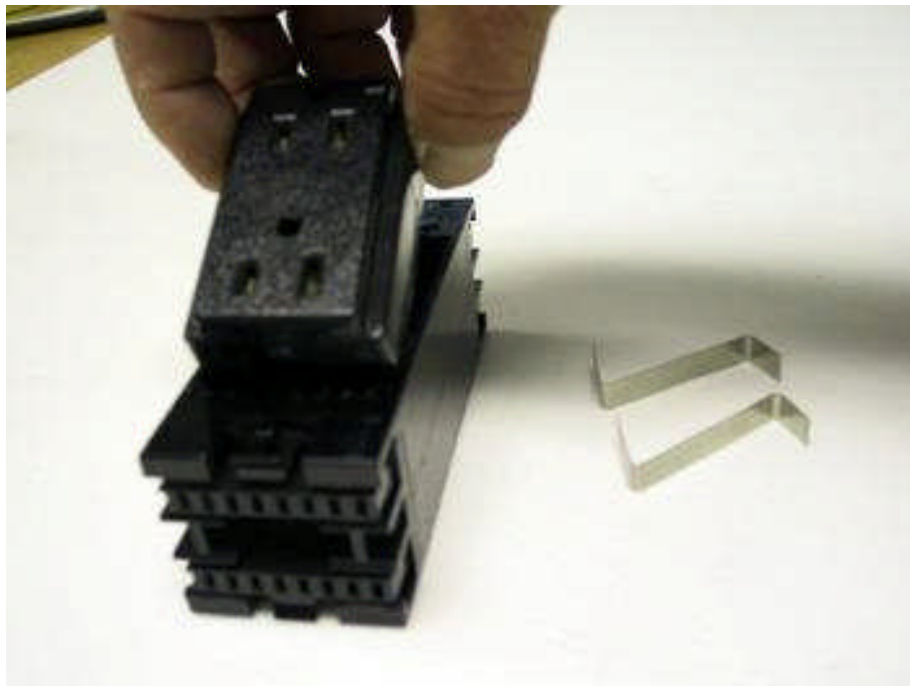

Picture 9-7 **Installing Junction Block into Powerport**



Picture 9-8 **Installing Powerport Clips**

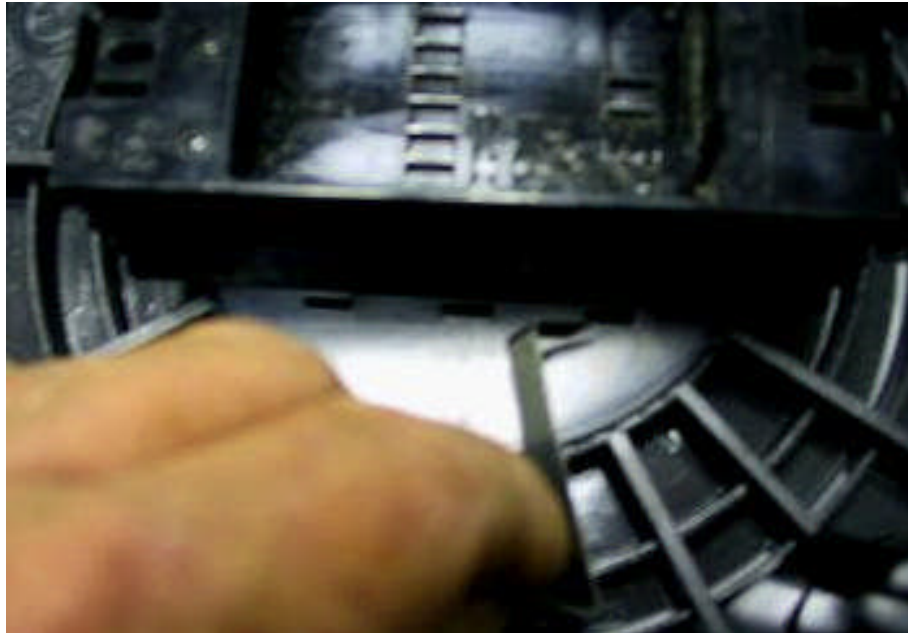

Picture 9-9

**Completely Installed Electrical Outlet
(Bottom View)**

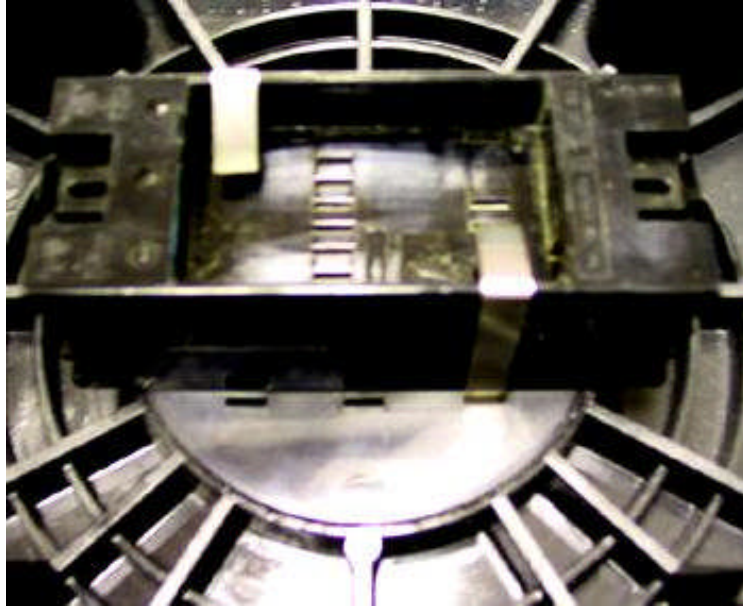

Picture 9-10

**Completely Installed Electrical Outlet
(Top View)**

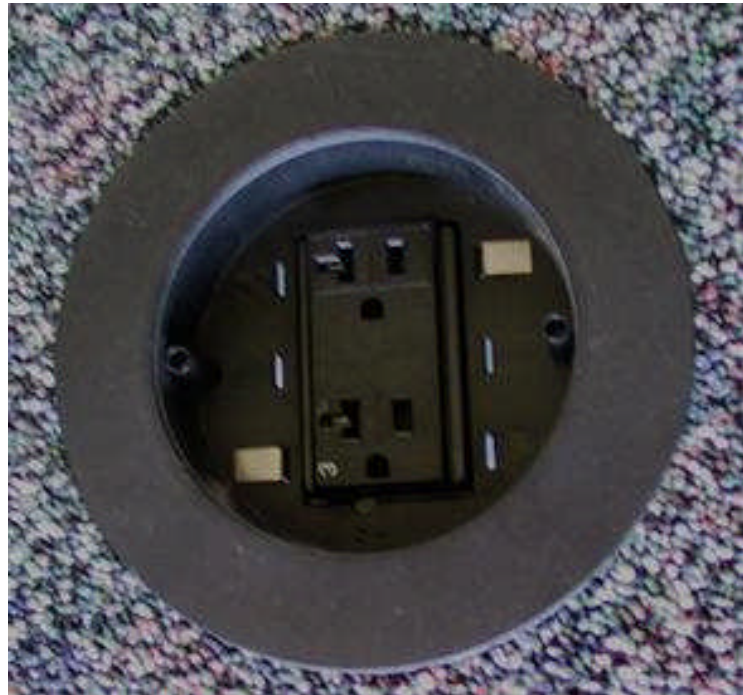

Picture 9-11 **Installing Double Ended Cable to Junction Block**
(Note keyway alignment)

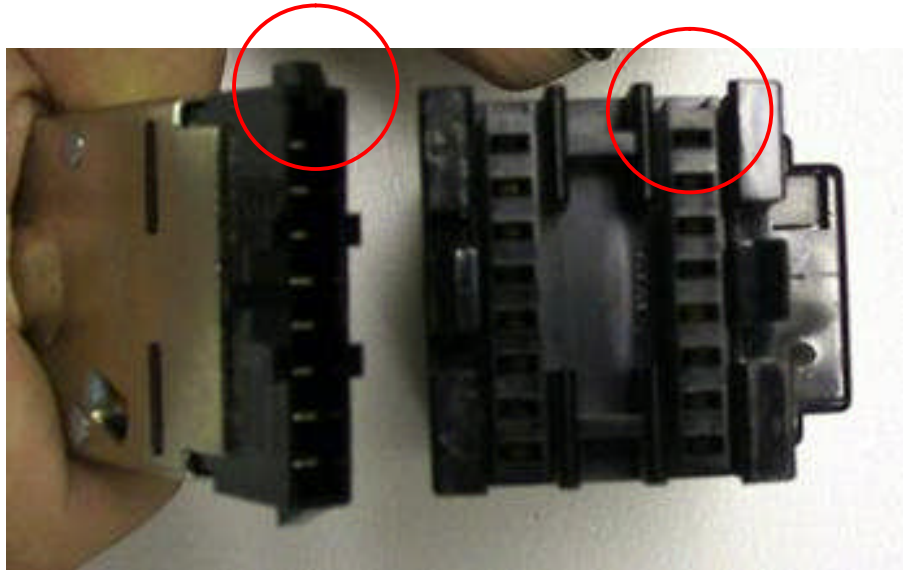

Picture 9-12 **Installed Cable Assembly to Junction Block**
Clip shall be firmly hooked on catch tab

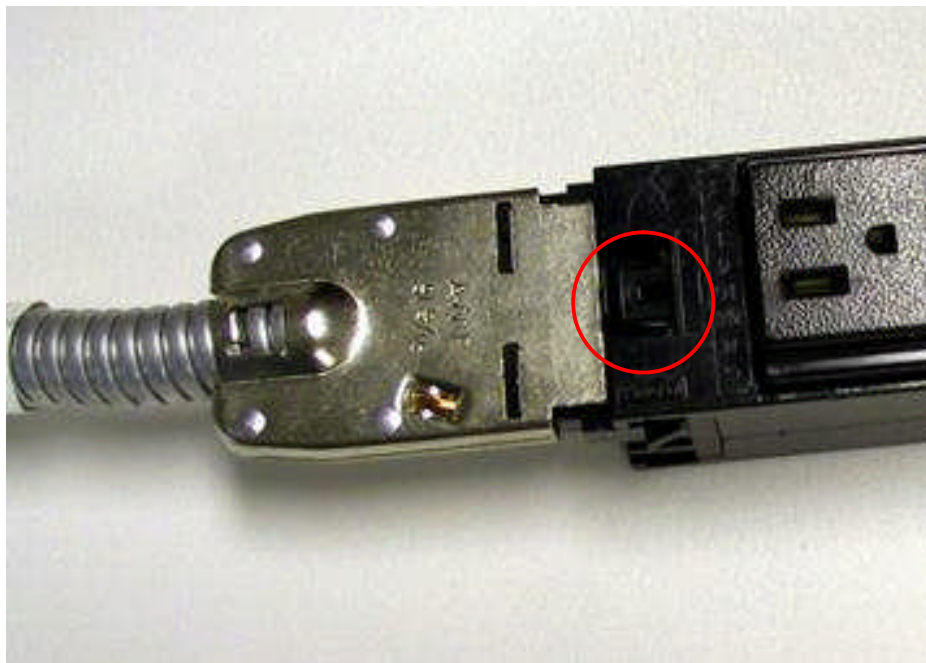

**Picture 9-13
Colored Electrical Tape**



**Picture 9-14
Applying Color Coding**



**Picture 9-15
Completed Color Coding of Cable Assembly**



Picture 9-16 **Completed Panel with Cable Assembly connected**



Picture 9-17 **Installing completed panel into system**

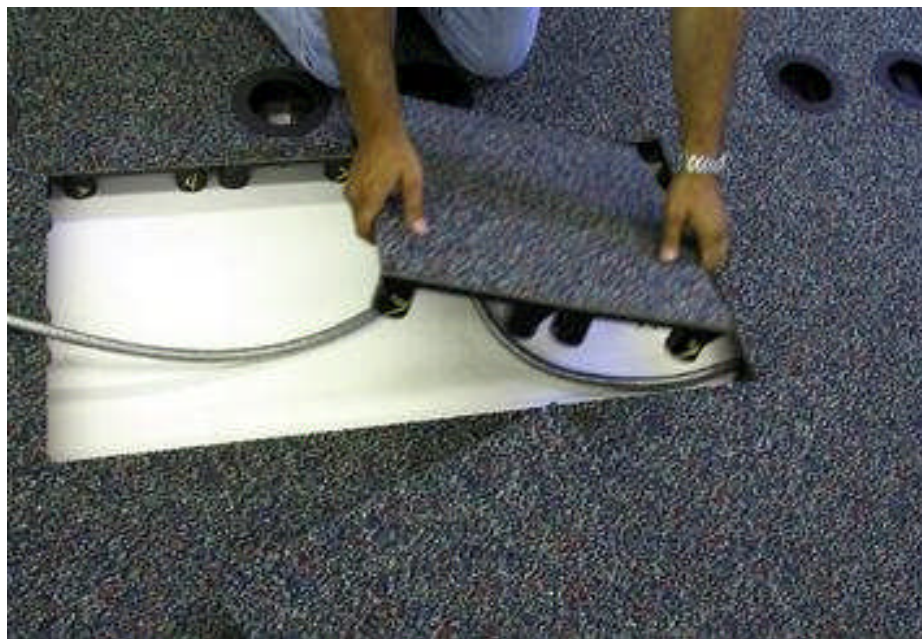

Electrical System Installation Procedure

PLEASE NOTE !!!!

Installation of electrical system should not be started before the entire floor structure is completely installed and cut in at all edges. The reason is that if you open up the floor to install the electrical while your people are walking on it and the edges are being cut, the panels will move. You will get inaccurate cuts resulting in gaps in the panels or will not be able to put the panels back into the floor.

Electrical should be completed before the Communication cabling and outlets are started.

The most effective procedure is when the floor is complete you can place the J Blocks, Clips, and appropriate Duplex Inserts at each outlet location. And locate and place the appropriate double ended cable assembly between the outlet locations..... **ON TOP OF THE FLOOR**



All cable assemblies & outlets can be plugged together, the cables can be color coded and a final check of layout can be made.

Once this is done you simply open up rows of panels, place the cables under the floor, mount the outlets, and replace all panels.

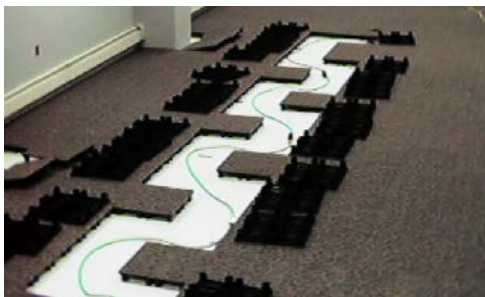

INSTALLING DATA/COMMUNICATIONS SYSTEM

- 1) The drawing will provide all the information necessary to install the Data Communication system. (see Detail Plan DC)
- 2) The drawing will determine the location of all data ports and the pre-terminated data cable length. (See Detail DC-1) For example the DE75 indicates a pre-terminated data cable, 75 feet long.
- 3) After determining the proper length data cable to be run from the Data / Comm outlet to the service point, un-package and number (if required) the data cable on both ends. (see Pictures 10-1)

Please Note ! The service point for the Data / Comm system may be a FFIT Floor LDS Utility Center or can be a client provided wiring closet. In either case determine the proper amount of cable length to be exposed for connection to the service point.

- 4) If an LDS Utility Center is to be used, the drawing will determine the location of the LDS. (see Detail DC-2)
- 5) The LDS Utility Center is provided as a cabinet, a base unit, and assembly hardware. (see Picture 10-2) The base shall be located into the FFIT Floor system, replacing one full panel. (see Pictures 10-3 & 10-4) The cabinet will require attachment to the base with 4 bolts and its assembly is self explanatory. (see Picture 10-5) Any patch panels, if provided by FFIT Floor, shall be installed on the LDS mounting track located per user preference. (see Picture 10-6)
- 6) The data cables leaving the LDS or the wiring closet will be tie wrapped at least every three feet to present a neat appearance (see Picture 10 -7). Cables shall be routed from under floor, through the LDS Base, through the side voids in the LDS Center, and plugged into the Patch Panel (if provided by FFIT Floor) (see Picture 10- 8) or left for connection by others
- 7) The LDS Utility Center when completed shall be made available to the client or his communication contractor for connection to services from the building. Once this work is done, the doors for the Utility Center shall be set in place and locked (see Picture 10- 9) with the keys, delivered to the appropriate party.
- 8) Some projects may be designed and specified for the client to provide Data / Comm electronics to be installed in the Utility Center. In these instances the Utility Center will not have any patch panels in it. If it is required FFIT Floor will provide a “ Bubble Back “ unit, to allow for the dimensional depth of the electronics. (see Picture 10-10) This unit is used as a replacement for one of the doors (typically the door facing behind the LDS) on the LDS Utility Center.

Please Note ! If project calls for a client provided wiring closet, or client provided patch panels, the FFIT Floor installation stops at the placement of the data cables in the wiring closet location or LDS at the network connection end of cables.

Section 10

Detail Plan DC

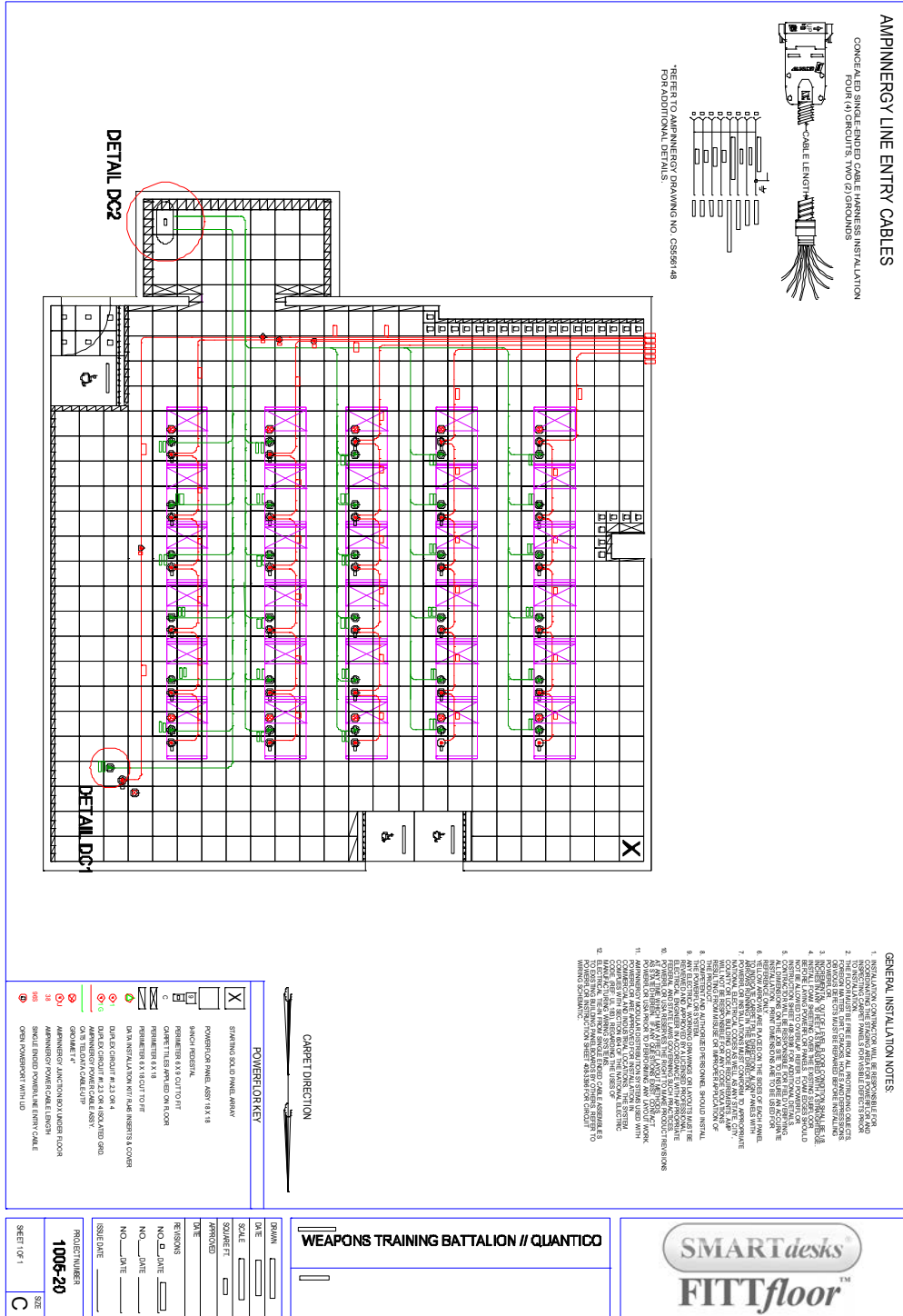

Detail DC-1

Drawing Detail Data / Comm Outlet & Cable

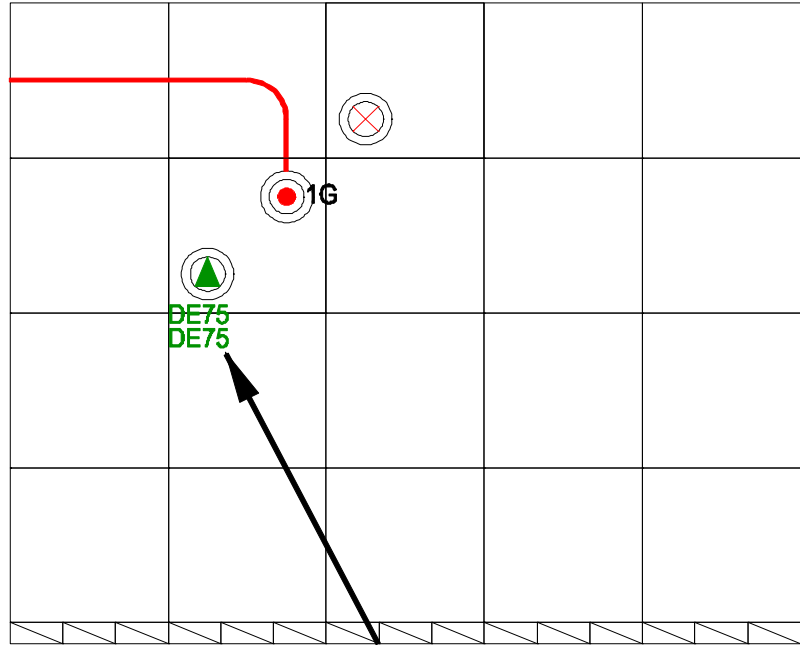

Detail DC-2

Drawing Detail - LDS

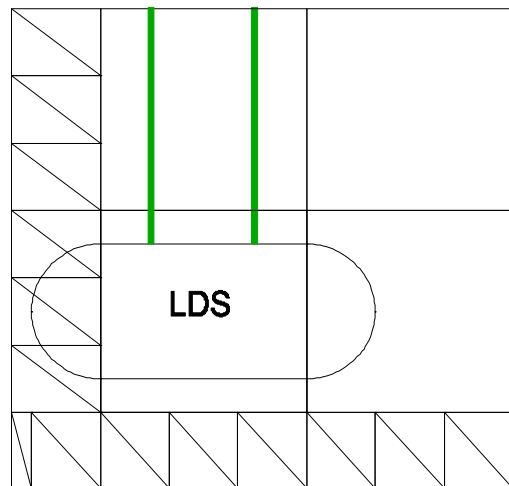

Picture 10-1 **Packaged Data Cables as provided**

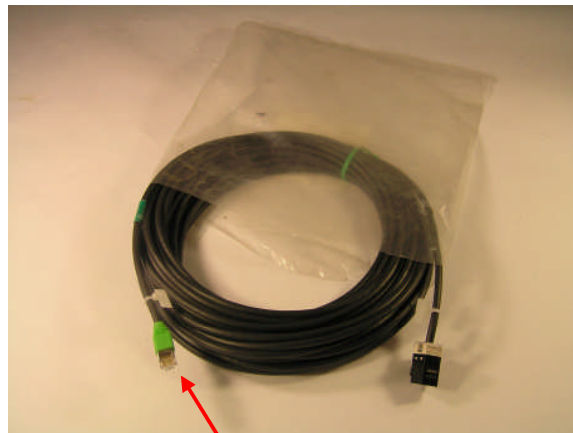

Network Connection End

Picture 10-2 **LDS Cabinet, Base, and Hardware as provided**

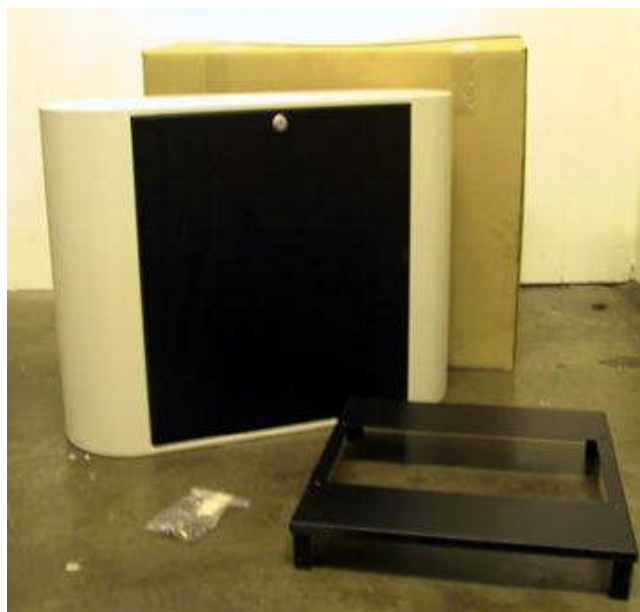

Picture 10-3 **18" x 18" or 50 cm x 50 cm x 3" high LDS Base Unit**



Picture 10-4 **LDS Base Unit located in floor system**



Picture 10-5 **Installing LDS Cabinet to Base Unit**



Picture 10-6 **Typical LDS Patch Panels**

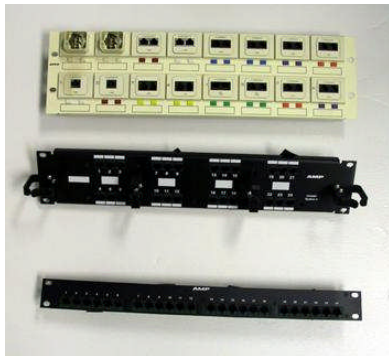

19" Wire Rack Mounting Bracket

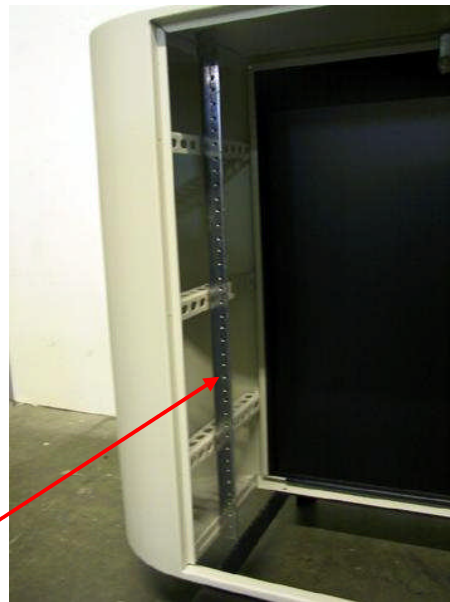

Picture 10-7

Pre-Terminated Data Cables at LDS or Wire Closet



Picture 10-8

LDS with Data Cables fed through base



LDS with Patch Panels and Data Cables

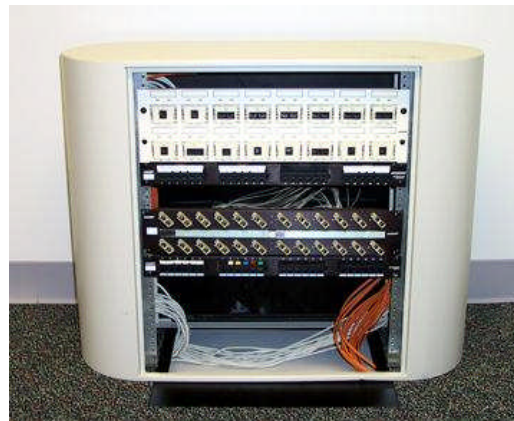

Connecting Data Cables to Patch Panel in LDS Cabinet

Picture 10- 9

LDS Center completely installed



Picture 10-10

Optional LDS Bubble Back



COMMUNICATION OUTLET & CABLE INSTALLATION

To complete the Data / Comm portion of the system, the outlets and cable assemblies are to be installed into the FFIT Floor system. This portion should not start until after you have completed the floor and electrical portions of the installation.

- 1) The standard Data / Comm components are the pre-terminated cable assemblies (see picture 10-11) and the mounting plate which is installed into the powerport grommet and receives the cable assembly connector (see picture 10 – 12).
- 2) All cabling will be rolled out to prevent its becoming damaged or tangled. The excess data cable length will be neatly rolled and tie wrapped at the outlet end to prevent the excess cable from becoming tangled or damaged in the future and to allow for future relocation of the outlet.

Please Note !!! Do not pull on ends of cable assemblies to straighten, roll out by hand. You will damage the cable !!! (see picture 10 – 13)

- 3) All cabling should be rolled out on top of floor in an appropriate manner consistent with the cable routing / bundling from the network connection end to the outlet (see picture 10 – 14).
- 4) Starting at the network connection end, open up the floor panels and place cabling on the sub-floor. Care must be taken to assure that the panel legs are not placed on top of the cable. The foam underlay will show impressions where these panel legs are. In some cases where cabling is springing, you can use a piece of duct tape to hold cabling in place, taping it to the foam (see Picture 10 – 15).
- 5) Cables are to be placed under the floor panels to each outlet with the Outlet connection end of the cable / cables running up through the appropriate powerport grommet, approximately 6” to 8” sticking out of the powerport (see Picture 10 – 16).
- 6) After all cables have been routed, bundled, placed under the floor panels. At each outlet location you take the Angled mounting plate and snap the outlet end connector into the back of the mounting plate (see Picture 10-17).
- 7) Once the connector and mounting plate have been snapped together you place the mounting plate into the powerport grommet, pushing the excess cable under the floor structure, pushing the mounting plate into the bottom of the powerport (see Picture 10-18).
- 8) Attach the mounting plate to the powerport with the two screws provided for this purpose (see Picture 10-19).
- 9) The communication outlet is completed (see Picture 10-20).

Picture 10-11

Pre-Terminated Cable Assemblies



Outlet Connection End

Picture 10-12

Angled Mounting Plate



Picture 10-13

Un-roll Cable / Do Not Pull



Correct !!! Hand over hand unrolling out.



Wrong !!! Pulled off the coil and pulled straight, will result in damage to the cable.

Picture 10-14

Rolling Out & Sorting Cabling on Top of Floor

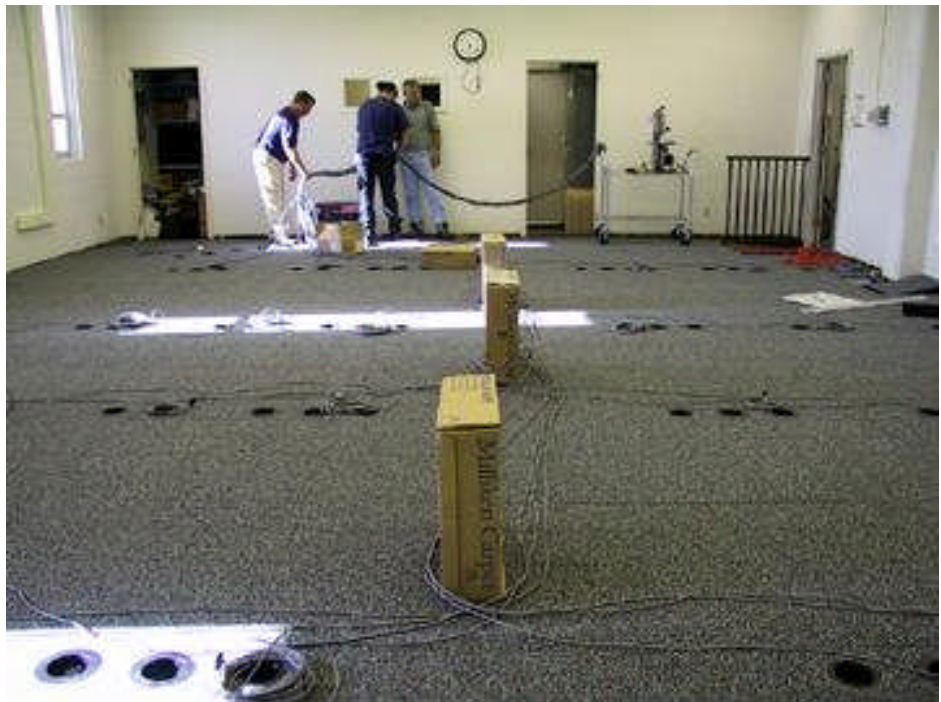

Tie Wrapping as Required



Picture 10-15

Opening Up Floor and placing Bundled Cables on Sub-Floor

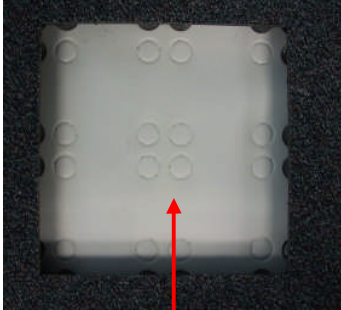

Panel Leg imprints in foam



Note Tie Wrap as cables split off to Outlets

Please Note ! Data cables will not be pulled or fished under the floor as a practice (only in a must do situations). All cables should be uncoiled (rolled out) and placed on top of system, bundled, then placed on the sub-floor and panels placed over them.

Picture 10-16

Cables Running through the Powerport



Picture 10-17

Connector snaps into Mounting Plate

Connector has fixed groove on one side and a tension clip on the other side for snapping it into the mounting plate with a rocking motion.

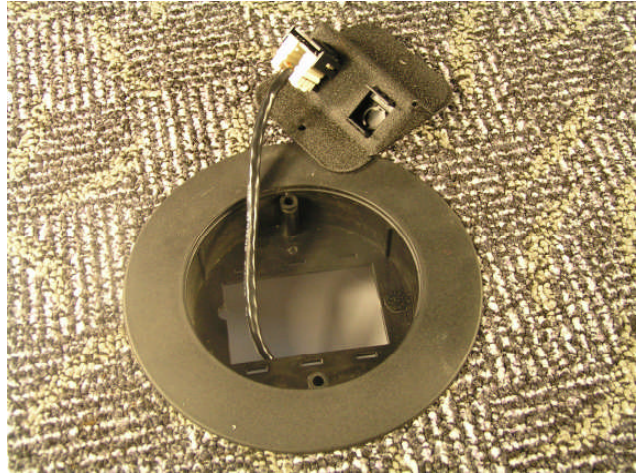

Picture 10-18

Mounting Plate is placed into the Powerport



Picture 10-19

Mounting Plate is attached to Powerport

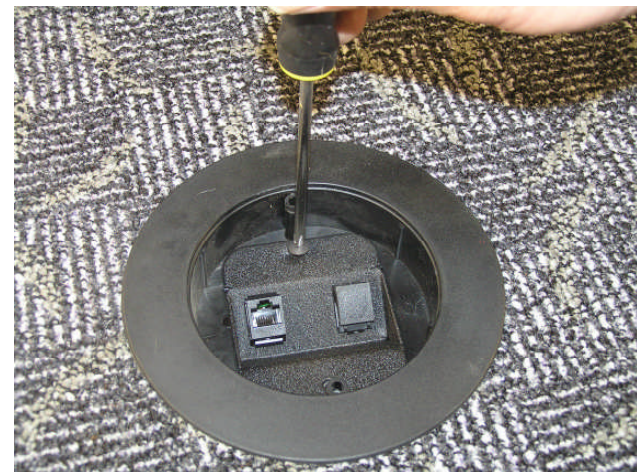

Picture 10-20

Completed Communication Outlet

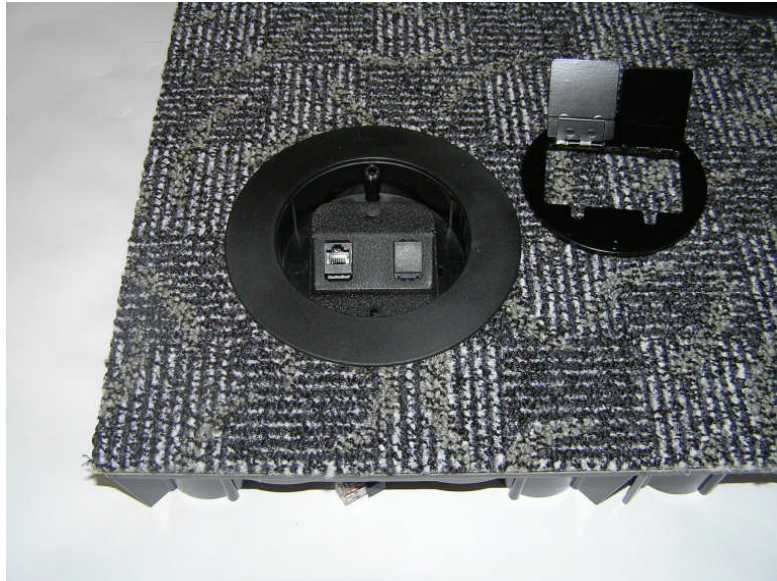

NON-STANDARD COMMUNICATION OUTLETS

Some projects require an alternative communication outlet connection. This can be desired because of connection quantity or manufacturers standards requirements where our standard outlet does not meet the client's requirements. FFIT Floor provides a Data Adaptor Plate. This adaptor plate allows for the installation of a wide selection of alternative data outlet device faceplates.

- 1) When using an alternative faceplate for mounting the Communication outlet connectors, you will be required to install a data adaptor plate into the powerport. (see Picture 10-21) The data adaptor plate will only fit into the powerport one way. The adaptor plate will be attached to the powerport with two screws through the pilot holes in the bottom of the powerport, in the same manner our Angled Mounting plate requires.
- 2) Insert the alternative faceplate by sliding the retaining tab onto the edge of the inner rectangular hole in the plate and pressing down until the retaining clip is fastened. (see Picture 10-22) Insert the appropriate connectors into the alternative faceplate and number accordingly.

Please Note ! When an alternative Communication outlet / faceplate is used, parts beyond the data adaptor plate may or may not be a FFIT Floor provided part. And pre-terminated Data / Comm cables may or may not be provided. In all cases, your work as an authorized installer for FFIT Floor will be limited to only and all parts of the system, provided by FFIT Floor.

If installing alternative faceplates and connectors is part of the FFIT Floor installation, it may be more time effective to install these items in the FFIT Floor Data Adaptor Plate, prior to installing it into the powerport.

Picture 10-21

Data Adaptor Plate & Powerport Grommet



Picture 10-22

Completed Adaptor Plate Outlet

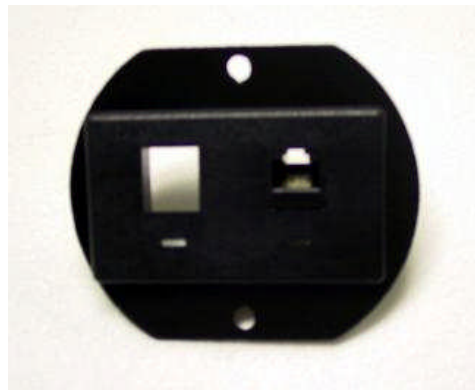
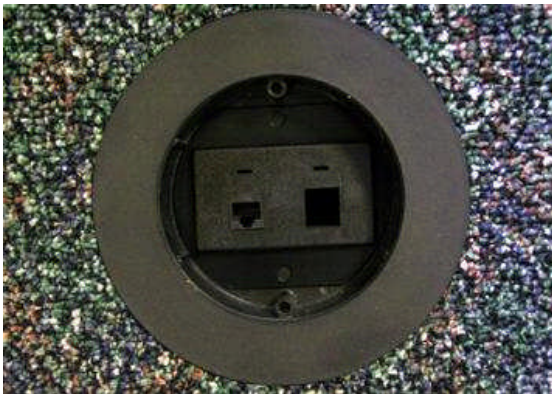

COMPLETING THE PROJECT

- 1) One of the final steps is the powerport lid placement. The standard powerport lid is a black metal lid with two flip doors to allow access to the outlet. (see Picture 11-1) The lids have two digit posts for alignment with and into alignment holes in the powerport. The lid is pressed into place so that it is firmly mounted into the powerport grommet (see Picture 11-2) These lids should be placed in such a manner to allow the flip doors to open in the same direction depending on the direction of the power port (i.e. all lids that open left or right should be in the same direction).
- 2) FFIT Floor also offers and your project may include several flat powerport lids, with and without cable holes through the lid. These lids are installed in the same manner as described for the standard lid, without any directional concerns. (see Picture 11-3)
- 3) Additionally, FFIT Floor offers a Domed Tamper-Proof lid. This lid must be attached with the two screws provided, using the powerport alignment holes as your screw location (see Picture 11-4).

As a final completion step, all debris should be removed and the floor vacuumed to leave an attractive and clean installation. All shipping materials removed from the jobsite, and all extra parts provided to the client.
(see Picture 11-4)

Picture 11-1

Standard Powerport Lid

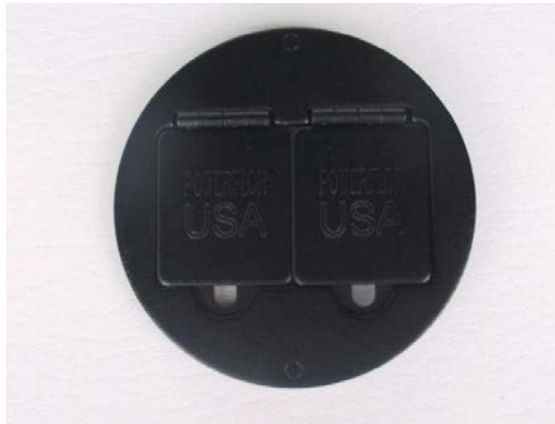

Picture 11-2

Pressing Lid into place



Picture 11-3

Powerport Flat Lid

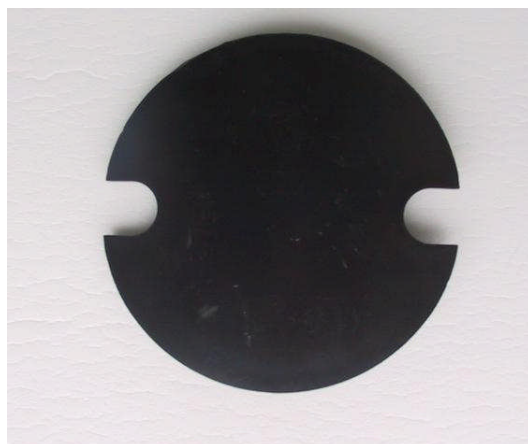

Picture 11-4

Powerport Tamper-Proof Dome Lid



Picture 11-5

Completed Room



RECESSED FLOORS

Recessed floors are becoming a common option / practice with new construction. This type of installation provides the FFIT Floor system without the need for any ramps or railings. The desire is to have a floor surface where the FFIT Floor system is not identifiable. Recessed type installations can be confined to a room or in the middle of an open area.

The sub-floor will be provided, recessed 2 5/8 inches to accommodate the FFIT Floor system in all areas where the system is to be installed. Although the entire surface is important, the edges of the recess area are critical to produce an even transition onto and off of the system area. (see Detail 12-1)

If the floor recess is more or less than 2 5/8 inches, at the edge area and horizontally into the recess 30", it must be chipped / ground out or built up / shimmed to produce the exact height and provide a smooth transition line.

Please Note ! The client and their contractors have been made aware of the importance of the dimensional integrity of the recessed areas. It is their responsibility to provide all recessed areas, with the correct recess. This can be easily checked by taking one of our perimeters or loose pedestals and sliding it around the edge, checking to make sure that the top of our un-carpeted parts are even with the raised sub-floor. If there are areas of concern, and they are of a minor nature, we recommend that they be taken care of as part of the installation. If there are major problem areas, do not begin the installation. Contact your FFIT Floor sales representative.

Installing the floor components in this type of installation is the same as a standard installation. Installing the carpet tiles on the perimeter pieces, may be different, if the recess is not consistent with a room's walls.

If the recess area's edge is not located where there is a wall or other fixed border the carpet tiles will lap over onto the sub-floor area that is even with the top of the FFIT Floor support structure. In cases where the recess is located in the middle of an open area the carpet tile will lap over all edges. In cases where the recessed area is consistent with a room, the carpet tiles will lap over to the raised sub-floor at door / access thresholds only. (see Pictures 12-1, 12-2, 12-3 & 12-4)

Please Note ! There are two important points to this type of installation.

One, whenever possible, the location of a carpet tile seam should not be at the edge of the recessed area, unless at a wall. Carpet tile should lap over the edge, from the system to the raised sub-floor.

Two, carpeting of the remainder of the areas around the system, should be done after the FFIT Floor system installation is complete, to insure a factory carpet tile edge to a factory carpet tile edge installation of the carpet tiles.

All other installation procedures for installing the floor remain the same.

Detail 12-1

Drawing Detail of Recessed Floor Slab

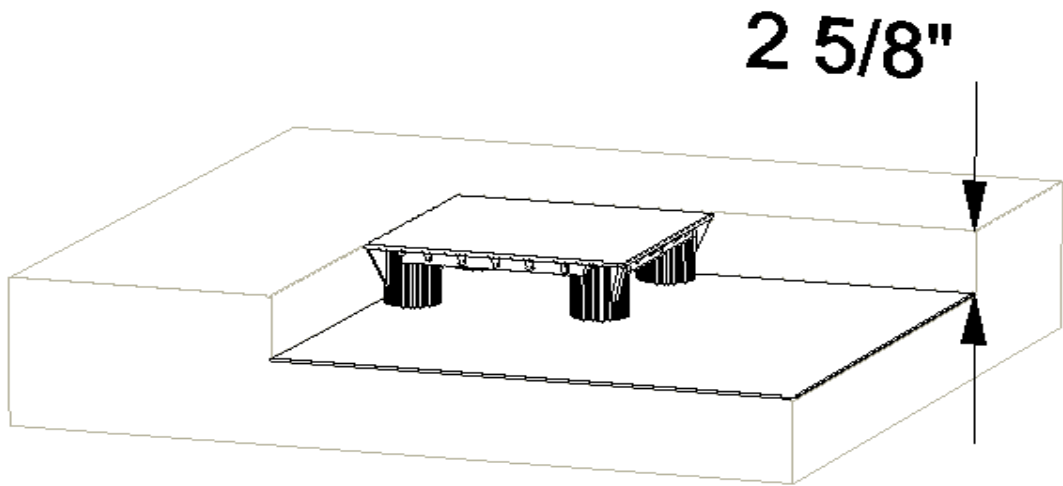
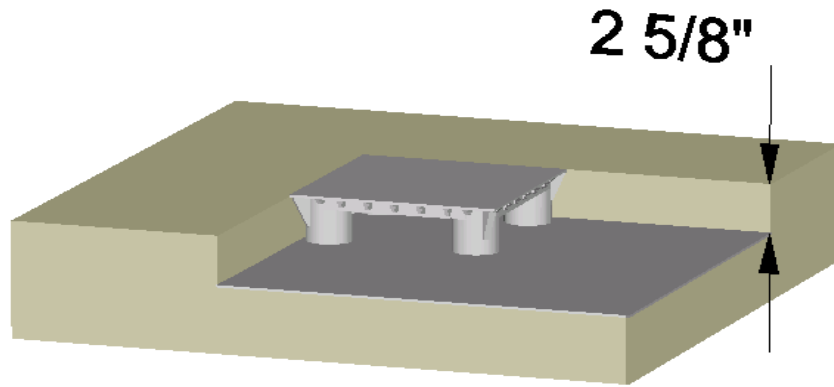

Picture 12-1 **Recessed Sub-floor at Door Opening with
Foam Underlay**



Picture 12-2 **Recessed Sub-floor with full panels requiring
perimeter filler**



Picture 12-3 **Recessed Sub-floor with full panels and perimeter filler installed**



Picture 12-4 **Recessed Sub-floor at Door Opening with full carpet tile overlaying perimeter and sub-floor seam**



OUTLET SERVICE & RELOCATION

General

The FFIT Floor Cable Management System provides for the relocation and change in service for all system, electrical and communication outlets. These changes typically can be accomplished very easily and quickly, without the need for specialized tools and without technical staff. The changes can be a simple change in an outlet's location, or can also include a change in the service to an outlet. The following procedures are recommended for performing these service changes.

Panel Removal & Replacement

An integral part of the relocation and / or service change of any outlet, includes the removal and replacement of the chaseway floor panels. The FFIT Floor system panels are not attached to each other or to the building structure. They are simply lifted up and out of their current location and can be replaced back into the system at any empty panel location.

- 1) Locate the panel containing the outlet / outlets you wish to service and remove the Powerport lid / lids.
- 2) Grasp the powerport and lift the panel out of the system. Once the carpet tile edges release from adjacent carpet edges, the panel easily lifts out of place. (see Pictures 14-1 & 14-2)

Please Note !! In some instances it is desirable to remove a panel that does not contain an outlet. In these instances, any flat bladed instrument (i.e. pen knife, putty knife, etc.) can be inserted into the seam between two panels, and by pushing down on the instrument, the panel comes up at its edge. (see Pictures 14-3, 14-4, & 14-5)

- 3) Removing adjacent panels in all directions is accomplished by simply grasping it's exposed edge and lifting out of place.
- 4) To return any panel to the system, simply place the panel back into any panel void. All full panels are interchangeable with each other, so any full panel location will receive any full panel. To maintain system flexibility you must replace panels maintaining the corner to corner panel locations.

Please Note !! When replacing any panel back into the system, you must maintain the carpet grain direction. Note the direction indicated by the yellow arrows on the side of the panel legs, and place the panel into the floor maintaining this direction for all other panels. (see Picture 14-6 & 14-7)

Also, care must be taken in assuring that the panel legs are not placed on any of the cabling underneath the panel. The leg impressions in the volara foam underlay will assist in panel location and cable placement. (see Pictures 14-8 & 14-9)

Picture 14-1



Picture 14-2



Picture 14-3



Picture 14-4



Picture 14-5



Picture 14-6



Picture 14-7

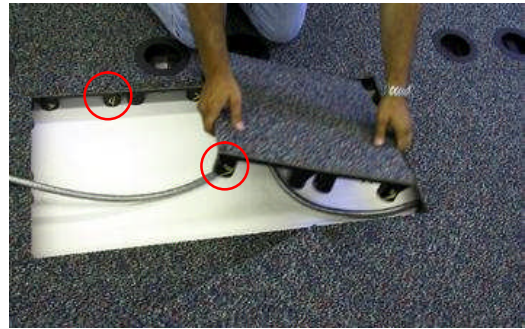

Picture 14-8

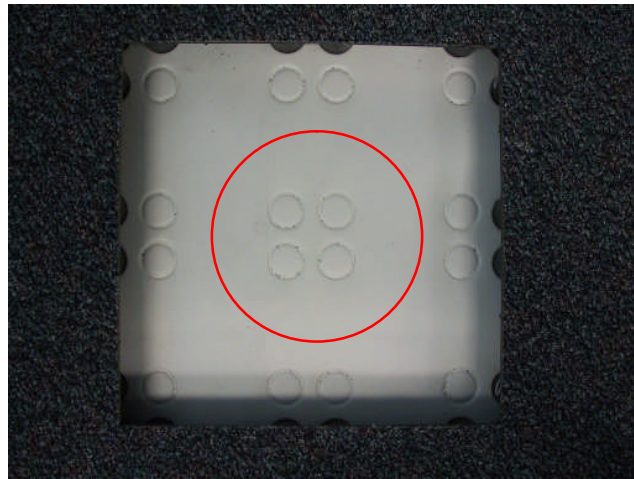

Picture 14-9

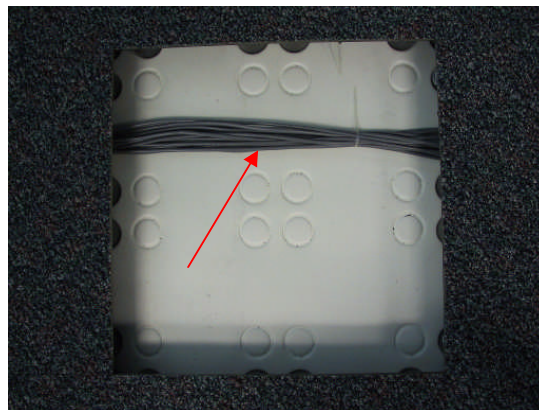

Electrical Outlet Relocation

Changing the location of an electrical outlet within the system.

- 1) Locate the panel that contains the electrical outlet you wish to relocate and remove the panel from the system as described previously.
- 2) Remove adjacent panels that cover the connecting cable / cables away from the panel / outlet to be relocated. (see Picture 14-10 & 14-11)
- 3) Enough panels should be removed to allow for the connecting cable / cables to be moved while maintaining the feed to the outlet being relocated.
- 4) Locate the panel with the outlet in it, to the new location, maintaining the corner to corner alignment of all panels. (see Pictures 14-12 & 14-13)
- 5) Adjust cable / cables to avoid the legs of the panels that cover them. (see Picture 14-14)
- 6) Replace all panels back into the system, as described previously. (see Picture 14-15)

The FFIT Floor system is designed to offer ample slack (approx. 20% of cable length) to allow for most outlet relocations. If your relocation requires more cable length than is available, disconnecting and reconnecting the cable / cables from the outlet is required.

When cables of additional length are required, they can be obtained from FFIT Floor. However, most system layouts involve cables of varying lengths. Typically as you are moving an outlet away from one point, you are moving towards another. You may wish to review the cable layout from the drawing prior to the change and plan on exchanging cable assemblies from other areas. This will allow for the relocation without new cable assemblies being required. If an exchange is made, it is important to maintain the color coding of the cable assemblies, and the power leg they are a part of.

Following are the recommended steps for this procedure.

- 1) After removing the panel with the outlet from the system, remove the outlet from the panel by releasing the two spring clips that hold it in place and pulling the electrical J Block from the powerport grommet. (see Picture 14-16)
- 2) This will expose the thumb clip that holds the cable assembly connector to the J Block. Lift this thumb clip and pull the cable assembly from the J Block. (see Picture 14-17)
- 3) After the appropriate cable / cables have been obtained or located, the cable assemblies plug into the J Block as required.

Please Note !!! When plugging the cable assembly into the J Block, care must be taken to align the matching keyways that are located on the internal side of the cable connector and external J Block plug area. (see Picture 14-18)

Picture 14-10

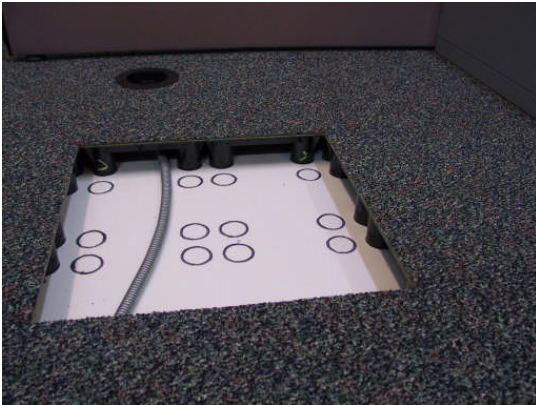

Picture 14-11



Picture 14-12

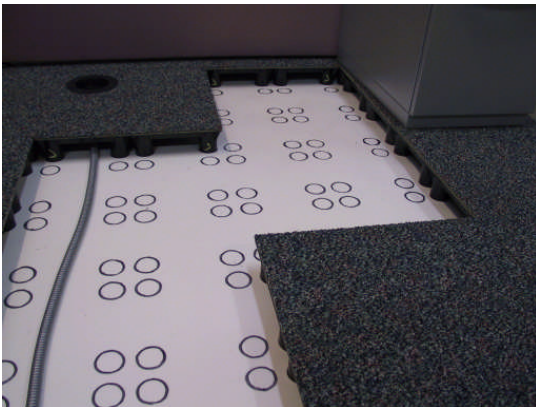

Picture 14-13

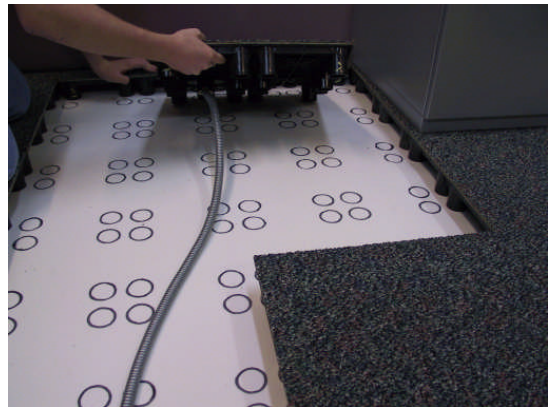

Picture 14-14

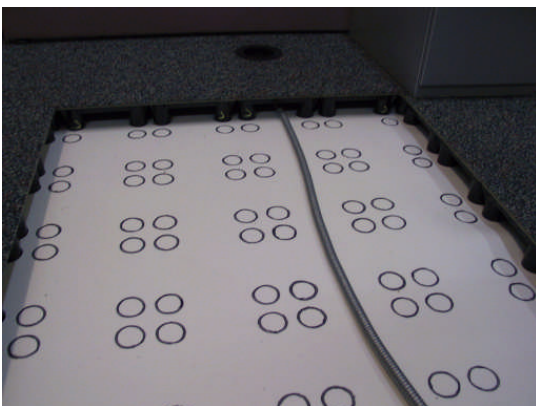

Picture 14-15

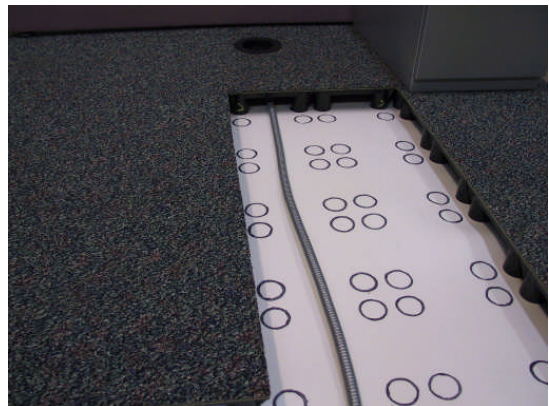

Picture 14-16

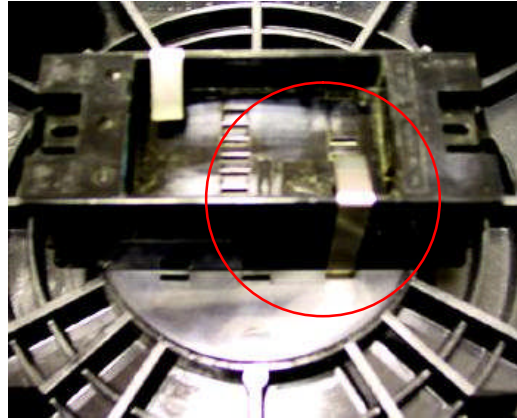

Picture 14-17

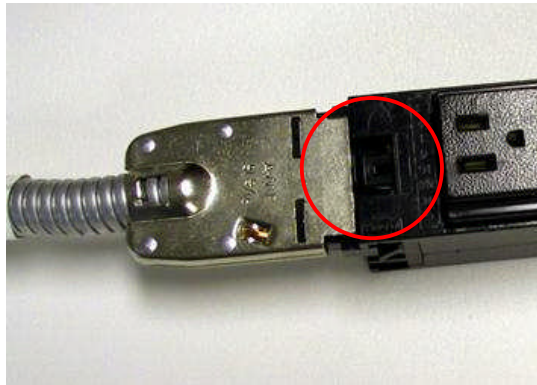

Picture 14-18

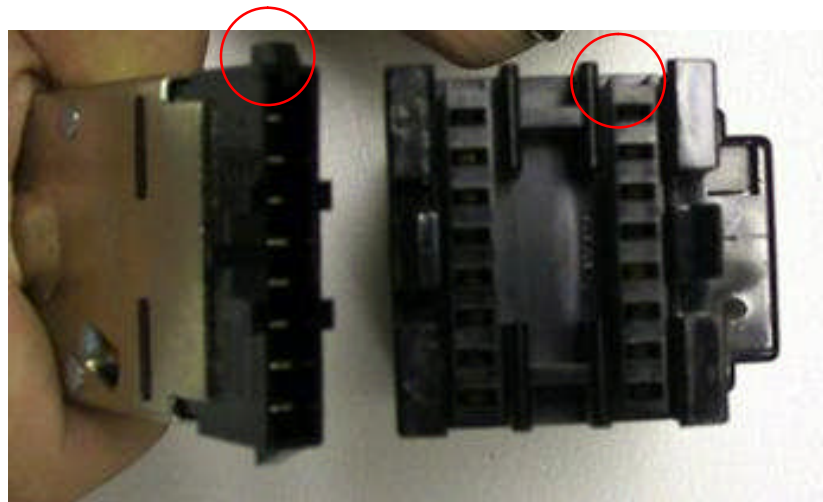

Electrical Outlet Service Change

Changing the circuit that powers an electrical outlet. The FFIT Floor electrical system provides four 20 ampere circuits, per power leg. Each leg is color coded with marking tape at each cable assembly end (see Picture 14-19). The circuit is identified on the outlet insert face (i.e. 1, 2, 3, or 4 for standard systems) and (i.e. 1G, 2G, 3G or 4G for isolated ground systems). (see Picture 14-20)

- 1) Locate the panel that contains the electrical outlet you wish to change the circuit feed for and remove the panel from the system as described previously.
- 2) After removing the panel with the outlet from the system, remove the outlet from the panel by releasing the two spring clips that hold it in place and pulling the electrical J Block from the powerport. (see Picture 14-16)
- 3) Remove the duplex outlet insert from the J Block by depressing the two tabs located on either end of the insert and unplugging the insert from the J Block. (see Picture 14-21)
- 4) Place the new insert with the circuit designation desired, aligning the tabs into the J Block, and push until it snaps into place.
- 5) Re-connect all cable assemblies and re-mount into the powerport.
- 6) Place panel into system as described previously.

Please Note !!!

When making any changes to the electrical system, make certain that the power is turned off to all circuits providing power to the system.

Review the project drawing and any changes to the system that have been previously performed. Note all changes you are making on the drawing.

Maintain the color coding of all electrical legs in the system.

Great care needs to be taken to assure that you do not plug two or more legs of power into each other !!!!

Picture 14-19

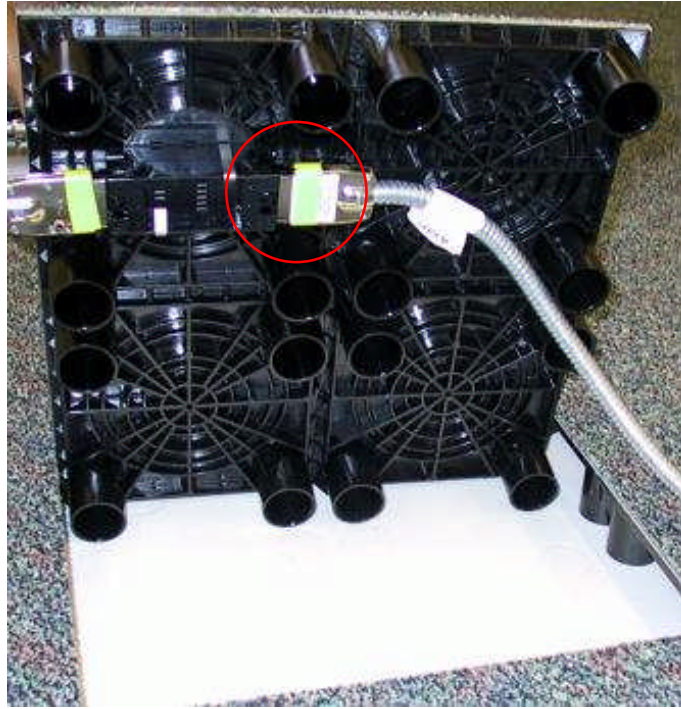

Picture 14-20



Picture 14-21

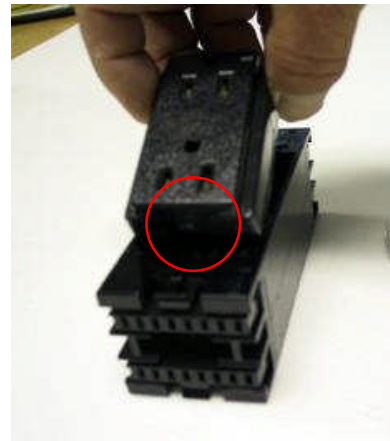

Communication Outlets / Relocation

Changing the location of a communication outlet within the system.

- 1) Locate the panel that contains the communication outlet you wish to relocate and remove the panel from the system as described previously (see Picture 14-22).
- 2) Remove adjacent panels that cover the communication cable away from the panel / outlet to be relocated. (see Picture 14-23)
- 3) Enough panels should be removed to allow for the communication cable to be moved while maintaining its connection to the outlet being relocated.
- 4) Locate the panel with the outlet in it, to the new location, maintaining the corner to corner alignment of all panels. (see Picture 14-24)
- 5) Adjust cable to avoid the legs of the panels that cover them. (see Pictures 14-25, 14-26 & 14-27)
- 6) Replace all panels back into the system, as described previously.

The FFIT Floor system is designed to offer ample slack to allow for most outlet relocations. Standard pre-terminated communication cables are provided in 25', 50', 75', 100', and 150' lengths. Review the communication cable layout as shown on the project drawing, prior to the change, to determine if new cables are required. When cables of additional length are required, they can be obtained from FFIT Floor.

Picture 14-22

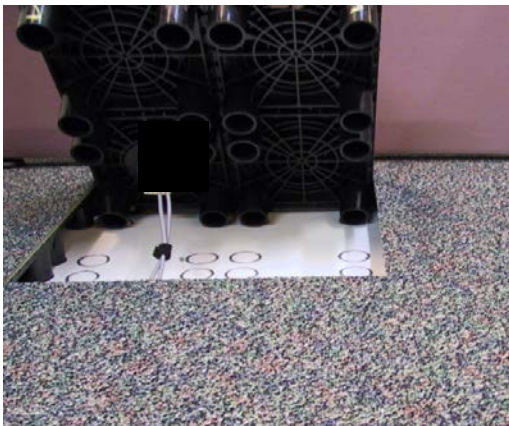

Picture 14-23

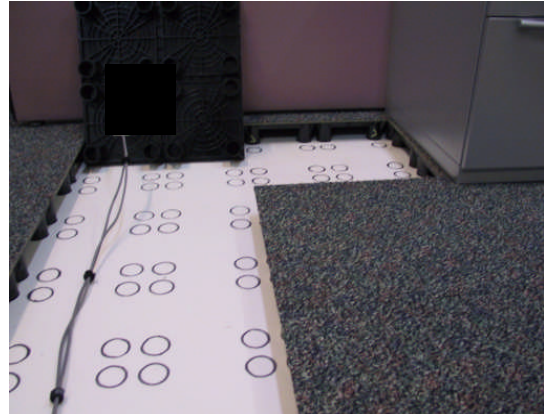

Picture 14-24

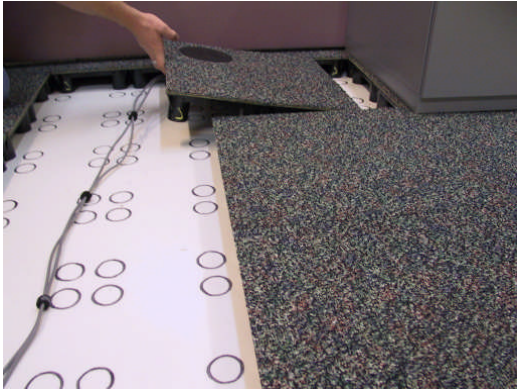

Picture 14-25

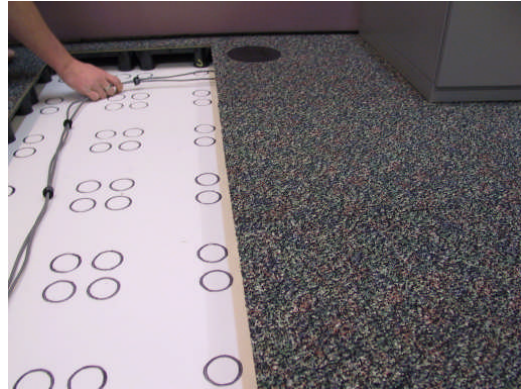

Picture 14-26

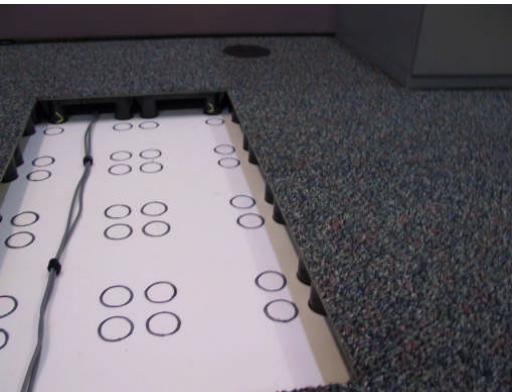

Picture 14-27

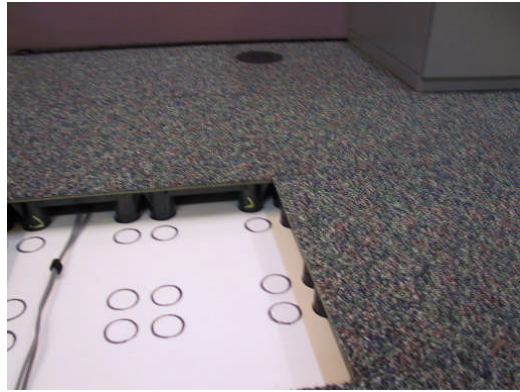

If your relocation requires more cable length than is available, disconnecting the existing cable and reconnecting a new cable from the outlet is required.

Following are the recommended steps for this procedure.

- 1) After removing the panel with the outlet from the system, turn the panel over and place it upside down on the floor, exposing the back of the communication outlet. (see Picture 14-28)
- 2) This will expose the Plug end of the cable assembly, which is “snapped” into the Angled Adaptor Plate. Un-snap the plug connector from the plate by depressing the side of the connector. Snap the plug connector from the new cable assembly into the adaptor plate and re-route cable back to service connection.. This may be easier to accomplish if you remove the screws holding the Angled Adaptor Plate into the powerport. (see Picture 14-29)
- 3) Replace all panels back into the system to complete the change. (see Picture 14-30)

Picture 14-28

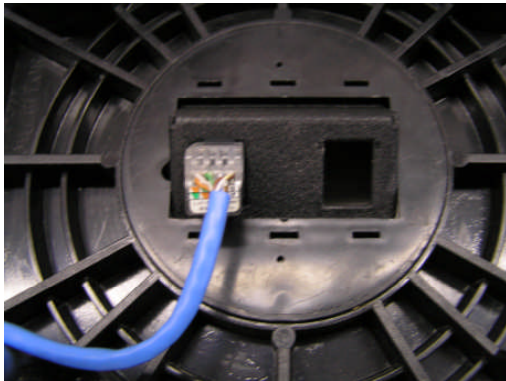

Picture 14-29



Angled Adaptor Plate

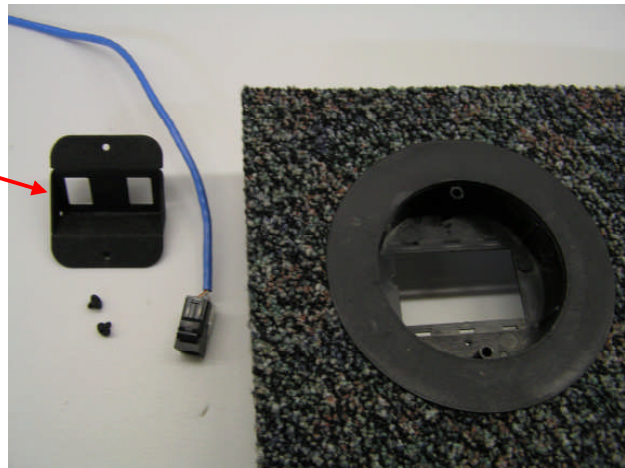

Picture 14-30



Adding an Outlet to an Existing System

Adding an outlet to your system can be easily accomplished, but will require additional parts. Please contact the factory to determine the parts required. You will require a powerport grommet base, powerport lid, and the appropriate electrical or communication outlet components. The lengths of the cabling required will need to be determined based on your new outlet's location and the service connection point to be used.

Please Note !!! The powerport grommet base can be used for **either the electrical or the communication outlet being added**. You will need one for each outlet being added.

You will need a 4" diameter Hole saw / 1/4" mandrill and appropriate drill to perform this task.

- 1) Determine your new outlet's location and remove the solid panel from the floor at that location (per previous instructions herein).
- 2) Place the panel upside down on a piece of scrape wood for protection of surface underneath.

Place the mandrill into the smallest hole in the quarter of the panel you wish to place the outlet and drill through the pedestal top and carpet.

Hold the panel firmly to prevent injury.



- 3) Turn the panel right side up, dust away any drilling debris and trim off any carpet fibers, providing a clean hole.
- 4) Position powerport grommet base and tap into place, so flange is firmly against carpet surface.

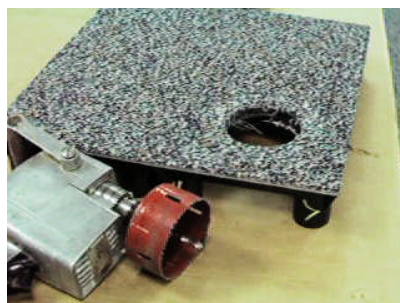

Once powerport grommet is installed into the panel, mount appropriate outlet components into the powerport and locate into the system per previous instructions.